







Safety Instructions

When using Shihlin inverters, please follow the installation to ensure the safety of user and others. The following instructions will be classified and described by icons:

 **DANGER** It means dangerous instructions, and incorrect handling may result in death or severe injury.

 **CAUTION** It means caution instructions. Incorrect handling may result in injury or property damage.

 It means caution and execution need to be done. Please operate according to the instructions.

 DANGER	<ul style="list-style-type: none"> ● Inverters must be used on the location except corrosive gas, water, flammable gas. ● Please operate far from flammable substance or explosives. ● Please do not lay the inverter on an intense trembling or shaking occasion. ● Do not operate wires soaked under oil or water. ● Prohibit touching any part in the inverter when power is ON to avoid electric shock. ● Three-phase power cannot be connected to terminal U/T1, V/T2, W/T3. ● The terminal  of the inverter must be correctly grounded. ● Do not conduct wiring when the power is ON.
 CAUTION	<ul style="list-style-type: none"> ● Do not conduct hi-pot test on internal components of the inverter, for semiconductor is easily damaged by high voltage. ● There are CMOS IC components on PCBAs which are especially sensitive to static electricity. Please do not touch PCBAs before taking anti-static measures. ● Even if the motor stops, a charge may still remain in the main circuit terminals of the inverter with hazardous voltages. ● Only qualified persons are allowed to install, wire and maintain the inverter. ● After some functions are set, the motor may start immediately once power is ON. ● Please choose the safe area to install the inverter, avoiding heat, direct sunlight, moisture humidity and splashing of droplets. ● When wiring between the inverter and motor is too long, it may damage the layer insulation of the motor. A reactor can be mounted between inverter and motor, avoiding insulation is damaged. ● For the installation power system of rated voltage, it cannot be over 240V for 220 series; it cannot be over 480V for 440 series.
	<ul style="list-style-type: none"> ● Only qualified personnel familiar with wiring is allowed to perform wiring. ● For the installation direction and method, please refer to the regulations. ● Make sure to use the temperature in a safe range. ● Please follow the installation to use the voltage. ● When there are problems in operation, please first unload the motor, after zero-load operation is OK, and then connect to the machine. ● Please confirm whether the inverter power is in line with the motor power. ● Before running, please confirm whether the emergency switch can operate normally. ● Power wire, U, V, W wires and signal wire should not be stranded, but separately. ● Please turn off the power if it is not used for a long time.

Safety Instructions

Other Precautions:

*1 If the product is ultimately used as a military unit, or when the product is used for weapons manufacturing, etc., this product will be included in the export product control object specified in the "Foreign Trade Law of PRC". When exporting, strict inspection and export procedures are required.

*2 In this manual, the case or the safety cover will be removed, and the description will be made in graphics and text in order to explain the product in detail. When operating, to ensure safety be sure to install the case and wire correctly according to the regulations referred in manual.

*3 Graphics in the manual are slightly different from the actual product for the convenience of illustrating, this will not affect customer rights.

*4 To improve our products, parameters and contents may be modified in the future, and the contents of this manual are subject to change without notice. Please download the latest version from Shihlin website (www.sseec.com.cn or www.seec.com.tw).

Contents

1. User Manual	1
2. Delivery Check	3
2.1 Nameplate Instruction	3
2.2 Type Instruction	3
2.3 Order Code Description	3
3. Introduction of Shihlin Inverter	4
3.1 Electric Specification	4
3.2 Common Specification (Inverter Characteristics)	6
3.3 Mechanical Dimensions	8
3.4 Name of Each Part	10
3.5 Installation and Wiring	12
3.6 Selection of Peripheral Equipments	26
4. Primary Operation	33
4.1 Operation Modes of the Inverter	33
4.2 Basic Operation Procedures for Different Modes	38
4.3 Operation	42
5. Parameter Description	44
5.1 Torque Boost (P.0, P.46) V/F	47
5.2 Range of the Output Frequency (P.1, P.2, P.18)	48
5.3 Base Frequency and Base Frequency Voltage (P.3, P.19, P.47)	49
5.4 Multi-speed (P.4~P.6, P.24~P.27, P.142~P.149)	50
5.5 Acceleration/Deceleration Time (P.7, P.8, P.20, P.21, P.44, P.45)	51
5.6 Electronic Thermal Relay Capacity (P.9)	53
5.7 DC Injection Brake (P.10, P.11, P.12)	53
5.8 Starting Frequency (P.13)	54
5.9 Load Pattern Selection (P.14, P.98, P.99, P.162~P.169)	55
5.10 JOG Mode (P.15, P.16)	58
5.11 Stall Prevention (P.22, P.23, P.66)	58
5.12 Output Frequency Filter Constant (P.28)	59
5.13 Acceleration/deceleration Curve Selection (P.29, P.255~P.258)	60
5.14 Regenerative Brake (P.30, P.70)	63
5.15 Soft-PWM Selection (P.31)	63
5.16 Communication Function (P.32, P.33, P.34, P.36, P.48~P.53, P.153~P.154)	64
5.17 Communication Running and Speed Command (P.35)	82
5.18 Speed Display (P.37, P.259)	82
5.19 Voltage Signal Selection and Target Frequency (P.38, P.73, P.139~P.141)	83
5.20 The Input Signal across Terminal 4-5 and the Target Frequency (P.17, P.39)	87
5.21 Multi-function Output (P.40, P.64, P.74, P.85, P.120 and P.187)	88
5.22 Up-to-frequency Sensitivity (P.41)	91
5.23 Output Frequency Detection (P.42, P.43)	92
5.24 AM Terminal (P.54~P.56, P.190, P.191)	93
5.25 Restart Function (P.57, P.58, P.150) V/F	94

Contents

5.26 The Choice of Locking Operation Keyboard Knob Setting (P.59).....	95
5.27 Input Signal Filter Constant (P.60).....	96
5.28 Remote Control Function Selection (P.61 , P.219).....	96
5.29 Zero Current Detection (P.62, P.63).....	99
5.30 Retry (P.65, P.67, P.68, P.69).....	100
5.31 Brake Selection (P.71).....	101
5.32 Carrier Frequency (P.72).....	102
5.33 Stop or Reset Function Selection (P.75).....	103
5.34 Parameters Write Protection (P.77).....	103
5.35 Forward/Reverse Rotation Prevention Selection (P.78).....	104
5.36 Operation Mode Selection (P.79).....	104
5.37 Multi-function Terminals Function Selection (P.80~P.84, P.86).....	105
5.38 Multi-Function Control-Terminal Input Positive/Negative Logic (P.87).....	110
5.39 Multi-Function Output Terminal Positive/Negative Logic(P.88).....	110
5.40 Slip Compensation Coefficient (P.89) V/F.....	111
5.41 The Inverter Model (P.90).....	111
5.42 Frequency Jump (P.91~P.96).....	112
5.43 The Second Frequency Source (P.97).....	112
5.44 Programmed Operation Mode (P.100~P.108, P.111~P.118, P.121~P.123, P.131~P.138).....	113
5.45 Operation Panel Monitoring Selection (P.110).....	115
5.46 The selection of positive and reverse rotation dead time (P.119).....	116
5.47 Zero-speed Function (P.151~P.152) V/F.....	117
5.48 Over Torque Detection (P.155~P.156, P.260).....	118
5.49 External Terminals Filter Adjusting Function (P.157).....	119
5.50 External Terminal Power Enable Function (P.158).....	119
5.51 Energy-saving Control Function (P.159) V/F.....	119
5.52 Multi-function Display (P.161).....	120
5.53 PID Control (P.170~P.183, P.223~P.225,P.251,P.253,P.254).....	121
5.54 4-5 Terminal Disconnection Handling (P.184).....	126
5.55 Proportion Linkage Function (P.185).....	127
5.56 Firmware version (P.188).....	127
5.57 Factory Setting Function (P.189).....	128
5.58 Input Signal across Terminal 2-5 (P.192~P.195).....	129
5.59 Input Signal across Terminal 4-5 (P.196~P.199).....	130
5.60 The Paver Function (P.226~P.228).....	131
5.61 Backlash Compensation and Acceleration/Deceleration Interrupted for Waiting Function (P.229~P.233) V/F.....	132
5.62 Triangular Wave Function (P.234~P.239) V/F.....	134
5.63 Auxiliary Frequency Function (P.240).....	135
5.64 DC Injection Brake Function before Starting (P.242~P.244) V/F.....	135
5.65 Options for Stopping the Cooling Fan (P.245).....	136
5.66 Commercial Power Supply Frequency Operation Function (P.247~P.250) V/F.....	137
5.67 Maintenance Alarm Function (P.261).....	140
5.68 Voltage stall action level (P.268).....	140

Contents

5.69 Vibration Inhibition Factor (P.286)	140
5.70 Short Circuit Protection Function (P.287)	141
5.71 Alarm History Parameters (P.288~P.291)	141
5.72 Accumulative Motor Operation Time Function (P.292, P.293)	142
5.73 Password Protection Function (P.294 and P.295)	142
5.74 Motor Control Mode (P.300 and P.301)	143
5.75 Motor Parameter (P.302~P.309)	145
5.76 Sliding Compensation Gain (P.320)	146
5.77 Torque Compensation Filter (P.321)	146
5.78 Parameter Copy Function (Pr.CP and Pr.CA) (DU06 operation panel needs to be purchased)	146
5.79 Alarm History Clear (P.996)	147
5.80 Inverter Reset (P.997)	147
5.81 Restoration of the Parameters to the Default Values (P.998 and P.999)	148
6. Inspection and Maintenance	149
6.1 Daily Inspection	149
6.2 Periodical Inspection (During Stop)	149
6.3 Regular Replacement for Some Components	150
6.4 Inverter Insulation Resistance Measurement	150
6.5 Motor insulation resistance measurement	150
6.6 IGBT Module Test	151
Appendix 1 Parameter list	152
Appendix 2 Alarm Code List.....	166
Appendix 3 Warning Code List	169
Appendix 4 Troubles and Solutions	170
Appendix 5 Optional Equipment	171
Appendix 6 European Specification Compatibility Description	173
Revision Record	175

1. User Manual

Shihlin Electric SS2-TYPE inverters possess many complex parameterized functions that meet most of the application requirements from the market. But for users who are unfamiliar with inverters, such a complex inverter may cause confusion. Please read the manual carefully to master the operation methods of the inverter. In case there is any question, please feel free to contact us.

In Chapter 3 of this manual, all series and the corresponding specifications of Shihlin Electric SS2-TYPE inverters are listed in detail. [Section 3.5](#) guides the users how to install the inverter and emphasizes on **safety precautions** when using the inverter.

Chapter 4 guides the users how to use the inverter. In [Section 4.1](#), the **operating mode of the inverter** is outlined and how to use the **operation panel** is described, and in [Section 4.2](#), simple operating steps are explained. Chapter 5 explains the functions of each parameter in detail.

Terminologies used in this manual are defined as follows:

1. Output frequency, target frequency, steady output frequency

- The actual output current frequency of the inverter is referred to as the output frequency.
- The frequency set by user (through operation panels, multi-speed terminals, voltage signals or current signals) is referred to as the target frequency.
- When the motor starts running, the output frequency of the inverter will gradually accelerate to the target frequency until reaching the target frequency and becoming steady. The output frequency at this time is referred to as the steady output frequency.

2. More detailed instructions on parameter settings are presented in Chapter 5. Please note that arbitrary adjustment of the parameters may result in abnormal operations. All parameters can be reset to their default values by the parameter [P.998](#). For offsetting this parameter, please refer to [P.998](#) in Chapter 5.

3. The operating mode of inverter and the working mode of the operation panel:

The operating mode determines the reference source for the target frequency and the signal source for starting. Shihlin inverter has totally nine operating modes. Please refer to [Section 4.1](#) for details.

The operation panel is used for numeric value monitoring, parameter setting and target frequency setting. Shihlin operation panel has totally five working modes. Please refer to [Section 4.1](#) for details.

4. The difference between terminal name and function name:

A set of printed letters can be found near the terminals of the control board or the main board. These letters are used to distinguish each terminal, and thus called 'terminal name'.

For multi-function control terminal and multi-function output terminal, function names have to be defined in addition to terminal names. A function name indicates the actual function of the terminal.

Function name is used to explain the functions of a terminal.

5. The difference between 'on' and 'turn on':

Both 'on' and 'turn on' are used for explaining the function for the Multi-function control terminal. The word 'on' is used to describe the state; that is, the external switch of the terminal is in the closed state.

The word 'turn on' is used to describe the action of shutting off the switch from the opened state to the closed state.

2. Delivery Check

Each SS2-TYPE inverter is inspected strictly before delivery and is packed carefully to prevent from mechanical damage. Please check as follows after opening the package.

- Please check whether it is damaged during transport.
- Please check whether the inverter type is identical with what is labeled on the package.

2.1 Nameplate Instruction

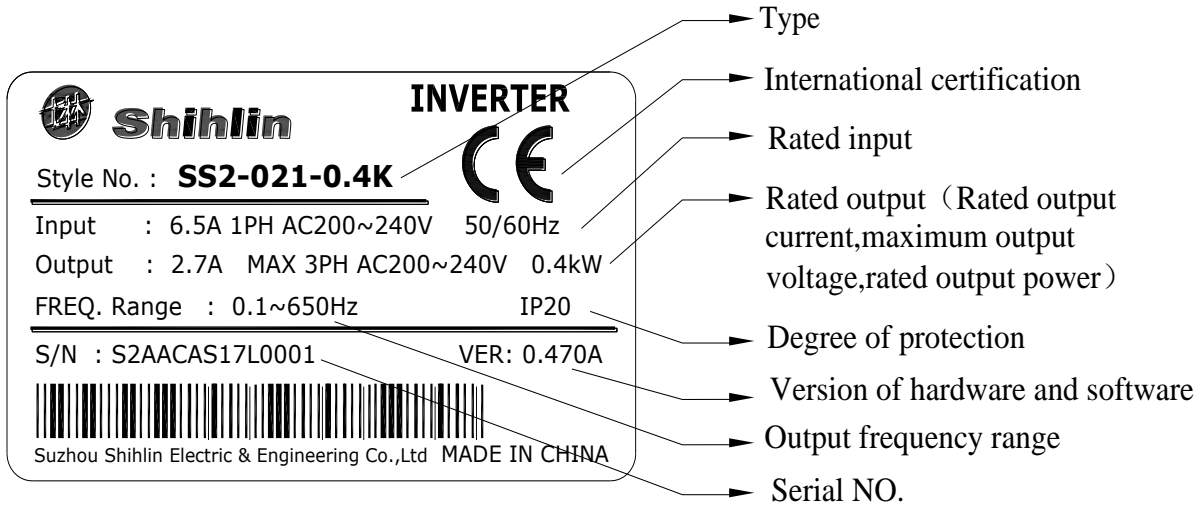

2.2 Type Instruction

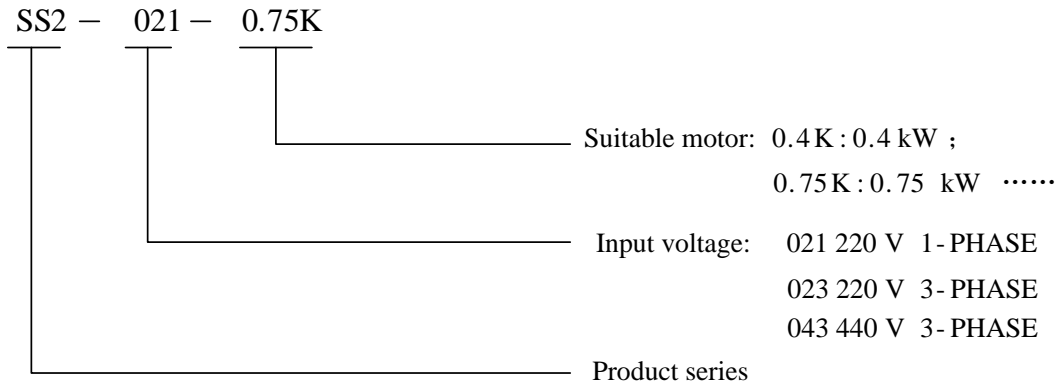

2.3 Order Code Description

For example:

Customer requirement	Order code
Inverter specification	
SS2-021-0.4K (SS2 Series Single-Phase 220V 0.5HP)	SNKSS20210R4K
SS2-023-1.5K(SS2 Series Three-Phase 220V 2HP)	SNKSS20231R5K
SS2-043-3.7K(SS2 Series Three-Phase 440V 5HP)	SNKSS20433R7K

3. Introduction of Shihlin Inverter

3.1 Electric Specification

3.1.1 220V Series Single-Phase

Model SS2-021-□□□K		0.4	0.75	1.5	2.2
Motor capacity	HP	0.5	1	2	3
	KW	0.4	0.75	1.5	2.2
Inverter Output	Rated output capacity (kVA)	0.95	1.5	2.5	4.2
	Rated output current (A)	2.7	4.5	8	11
	Overload current rating	150% 60 seconds, 200% 1 seconds (inverse-time characteristics)			
	Maximum output voltage	3 phase 200~240V			
Power Supply	Rated input AC voltage/ frequency	Single phase 200~240V 50Hz / 60Hz			
	Permissible AC voltage fluctuation	Single phase 170~264V 50Hz / 60Hz			
	Permissible frequency fluctuation	±5%			
	Power supply capacity (kVA)	1.5	2.5	3.5	6.4
	Rated input current (A) *Note 1	6.5	9.3	15.7	24
Cooling method		Self cooling	Fan cooling		
Weight (kg)		1.1	1.2	1.6	1.7

Note 1: The value indicates the current at rated output. The rated input current value is not only affected by power transformer, input side reactor, wiring condition, but also fluctuates with the impedance of the power supply side.

3.1.2 220V Series Three-Phase

Model SS2-023-□□□K		0.4	0.75	1.5	2.2	3.7
Motor capacity	HP	0.5	1	2	3	5
	KW	0.4	0.75	1.5	2.2	3.7
Inverter Output	Rated output capacity (kVA)	1.2	2	3.2	4.2	6.7
	Rated output current (A)	3	5	8	11	17.5
	Overload current rating	150% 60 seconds, 200% 1 seconds (inverse-time characteristics)				
	Maximum output voltage	3 phase 200~240V				
Power Supply	Rated input AC voltage/ frequency	3 phase 200~240V 50Hz / 60Hz				
	Permissible AC voltage fluctuation	3 phase 170~264V 50Hz / 60Hz				
	Permissible frequency fluctuation	±5%				
	Power supply capacity (kVA)	1.5	2.5	4.5	6.4	10
	Rated input current (A) *Note 1	3.2	5.6	9.3	15	20.6
Cooling method		Self cooling	Fan cooling			
Weight (kg)		1.1	1.2	1.2	1.6	1.7

Note 1: The value indicates the current at rated output. The rated input current value is not only affected by power transformer, input side reactor, wiring condition, but also fluctuates with the impedance of the power supply side.

3.1.3 440V Series Three-Phase

Model SS2-043-□□□K		0.4	0.75	1.5	2.2	3.7	5.5	
Motor capacity		HP	0.5	1	2	3	7.5	
		KW	0.4	0.75	1.5	2.2	3.7	5.5
Inverter Output	Rated output capacity (kVA)		1	2	3	4.6	9.2	
	Rated output current (A)		1.5	2.6	4.2	6	9	12
	Overload current rating		150% 60 seconds, 200% 1 seconds (inverse-time characteristics)					
	Maximum output voltage		3phase 380~480V					
Power Supply	Rated input AC voltage/ frequency		3 phase 380~480V 50Hz / 60Hz					
	Permissible AC voltage fluctuation		3 phase 323~528V 50Hz / 60Hz					
	Permissible frequency fluctuation		±5%					
	Power supply capacity (kVA)		1.5	2.5	4.5	6.9	10.4	13.8
	rated input current A (Note 1)		1.8	3.2	4.3	7.1	10	14
Cooling method		Self cooling			Fan cooling			
Weight (kg)		1.1	1.1	1.2	1.6	1.7	1.7	

Note 1: The value indicates the current at rated output. The rated input current value is not only affected by power transformer, input side reactor, wiring condition, but also fluctuates with the impedance of the power supply side.

Note: The test conditions of rated output current, rated output capacity and frequency converter inverter power consumption are: the carrier frequency (P.72) is at factory setting value; the frequency converter/inverter output voltage is at 220V/440V; the output frequency is at 60Hz, and the ambient temperature is 50°C.

Introduction of Shihlin Inverter

Common Specification (Inverter Characteristics)

3.2 Common Specification (Inverter Characteristics)

Control Method		SVPWM control, V/F control, general flux vector control.		
Output Frequency Range		0. 1~650Hz (The starting frequency setting range between 0 and 60Hz).		
Frequency Resolution	Digital setting	If the frequency value is set below 100Hz, the resolution will be 0.01Hz. If the frequency value is set above 100Hz, the resolution will be 0.1Hz.		
	Analog setting	When setting the signal DC 0~5V, the resolution will be 1/500; When setting the signal DC 0~10V or 4~20mA, the resolution will be 1/1000.		
Output Frequency Accuracy	Digital setting	Maximum target frequency $\pm 0.01\%$.		
	Analog setting	Maximum target frequency $\pm 0.5\%$.		
Voltage / Frequency output Characteristics		Base frequency voltage (P.19), base frequency (P.3) can be arbitrarily set. Constant torque model and applicable load model can be selected (P.14).		
Start Torque		150% 3Hz, 200% 5Hz: when using the facility vector control.		
Torque Boost		The torque boost setting range between 0 and 30% (P.0), auto boost, slip compensation.		
Acceleration / Deceleration Curve Characteristics		The resolution (0.01s/0.1s) of acceleration/deceleration time (P.7, P.8) is switched by P.21. The setting range has 0~360s or 0~3600s for selection. And different acceleration/deceleration curve model can be selected by P.29.		
DC Braking		The DC braking action frequency range between 0 and 120Hz (P.10); the DC braking time is 0~60 Seconds (P.11); and the DC braking voltage is 0~30% (P.12). Linear braking and idling braking selection (P.71).		
Stalling Protection		The stalling protection level can be set between 0 and 250% (P.22).		
Target Frequency Setting		Operation panel setting; DC 0~5V signal setting, DC 0~10V signal setting and DC 4~20mA signal setting, two voltage input or one voltage and one current input can be selected, Multi-speed stage levels setting, Pulse frequency setting, Communication setting.		
PID Control		Please refer to P.170~P.183 in Chapter 5.		
Multifunction Control Terminals		Motor starting (STF, STR), the second function (RT), '16-speed operation' (RL, RM, RH, REX), external thermal relay (OH), reset (RES), etc. (they can be set by the user with P.80~P.84, P.86)		
Multi-function Output Terminals	Multi-function output terminals	SO, SE	P.40	Inverter running (RUN), output frequency detection (FU), Up to frequency (SU), overload detection (OL), zero current detection (OMD), alarm (ALARM),
	Multi-function output relay	A, B, C	P.85	Section detection (PO1), Periodical detection (PO2), and Pause detection (PO3), Inverter output (BP), Commercial power-supply output (GP).
	Analog output	AM, 5		Multi-function DC (0~10V) Output: output frequency, output current (P.54).

Introduction of Shihlin Inverter

Common Specification (Inverter Characteristics)

Operation Panel	Running status monitoring	Output frequency monitoring, output current monitoring, and output voltage monitoring.
	HELP mode	Alarm history monitoring.
	LED indication lamp(6)	Run indication lamp, frequency monitoring indication lamp, voltage monitoring indication lamp, current monitoring indication lamp, mode switching indication lamp, and PU control indication lamp.
Communication Function	RS485	Internal RS485 communication, RJ-45 connector.
Protection Mechanism / Alarm function		Output short circuit protection, Over-current protection, (+/P)-(-/N)over-voltage protection, under-voltage protection , motor over heat protection (P.9), IGBT module over-heat protection, braking transistor abnormality protection, communication abnormality protection, etc.
Environmental Condition	Ambient temperature	-10 ~ +50°C (non-freezing), installation side by side -10~ +40°C.
	Ambient humidity	Below 90% Rh (non-condensing)
	Storage temperature	-20 ~ +65°C
	Operating environment	Indoor, no corrosive gas, no flammable gas, no flammable dust
	Altitude and vibration	Altitude below 1000 meters, Vibration below 5.9m/s ² (0.6G).
	Grade of protection	IP20
	The degree of environmental pollution	2
	Class of protection	Class I
Certification		

3.3 Mechanical Dimensions

3.3.1 Frame A

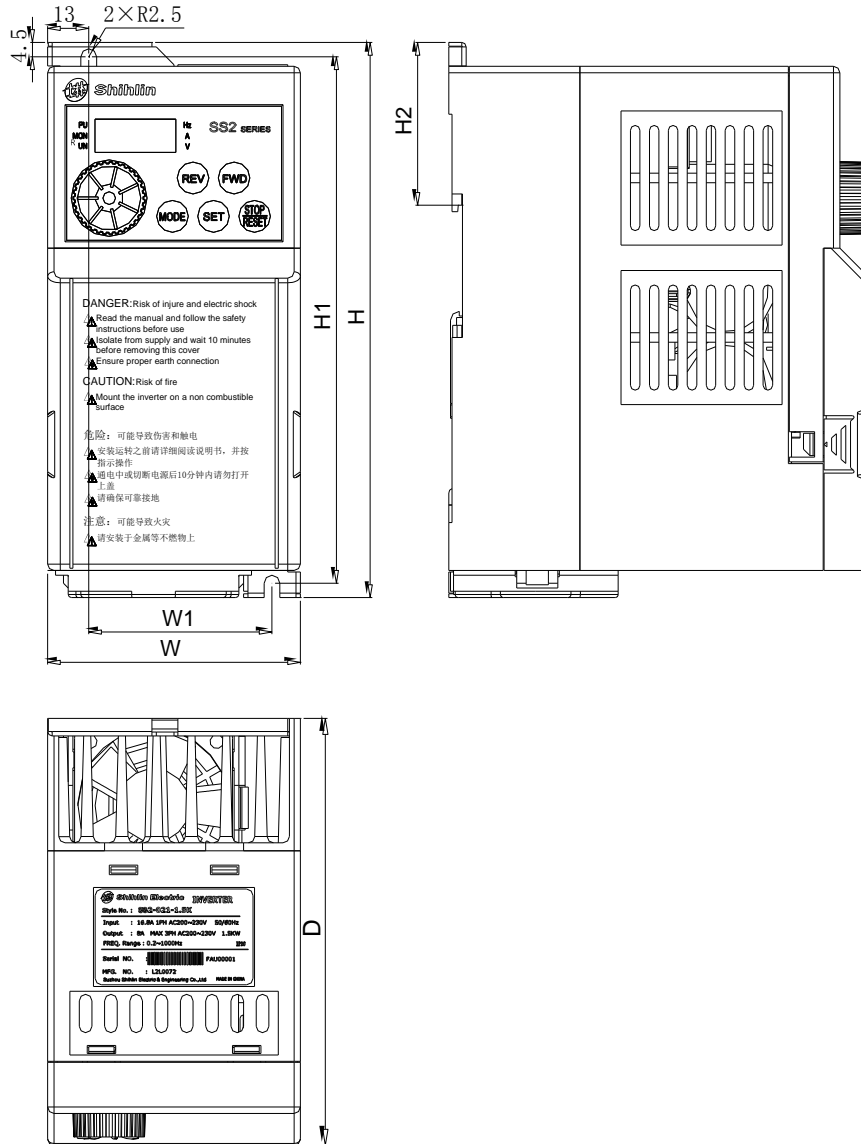

Model	H	H1	H2	W	W1	D
SS2-021-0.4K	174	165	51.5	80	58	134
SS2-021-0.75K						
SS2-023-0.4K						
SS2-023-0.75K						
SS2-023-1.5K						
SS2-043-0.4K						
SS2-043-0.75K						
SS2-043-1.5K						

3.3.2 Frame B

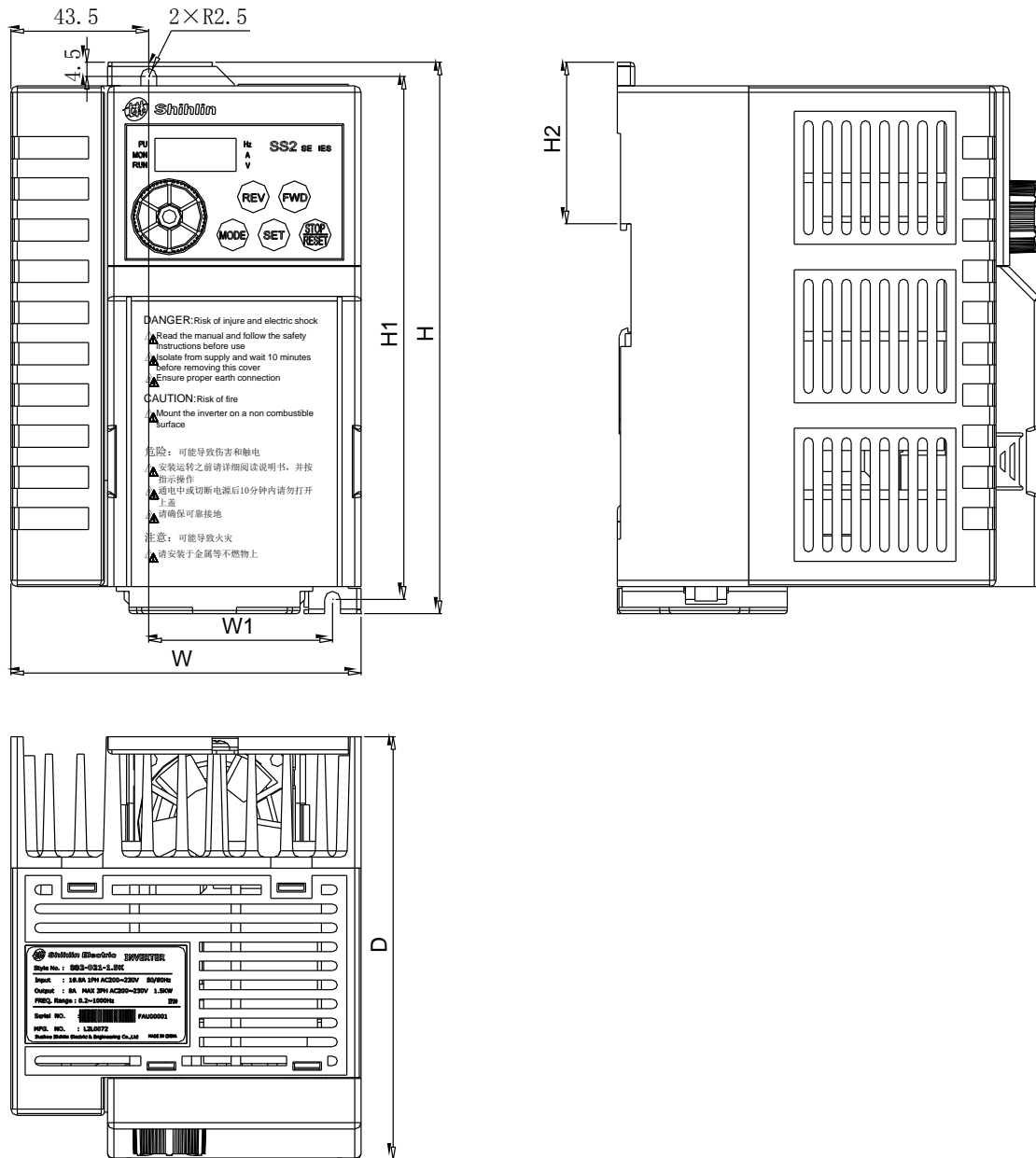

Model	H	H1	H2	W	W1	D
SS2-021-1.5K	174	165	51.5	110.5	58	134
SS2-021-2.2K						
SS2-023-2.2K						
SS2-023-3.7K						
SS2-043-2.2K						
SS2-043-3.7K						
SS2-043-5.5K						

3.4 Name of Each Part

3.4.1 Nameplate and model

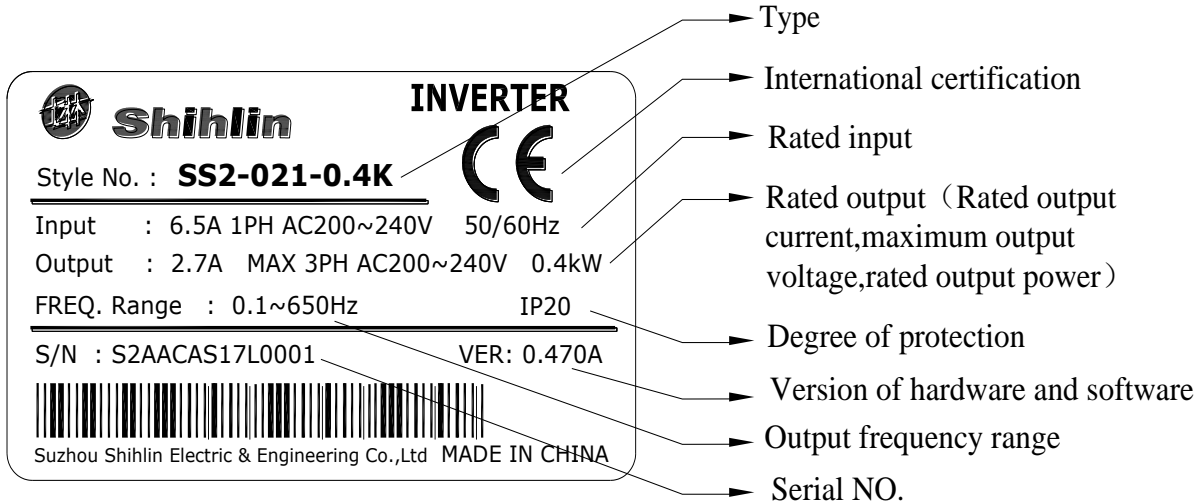

3.4.2 Names of the components

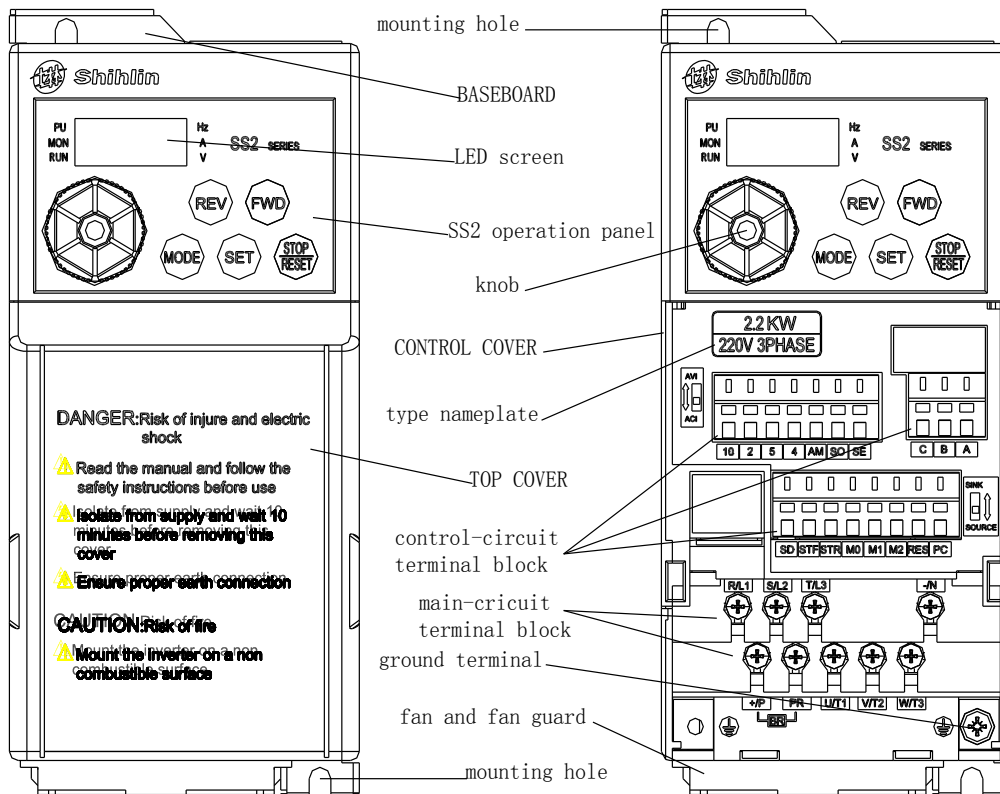

Note: 1. The enlarged figure of the control-circuit terminal block is as follows:

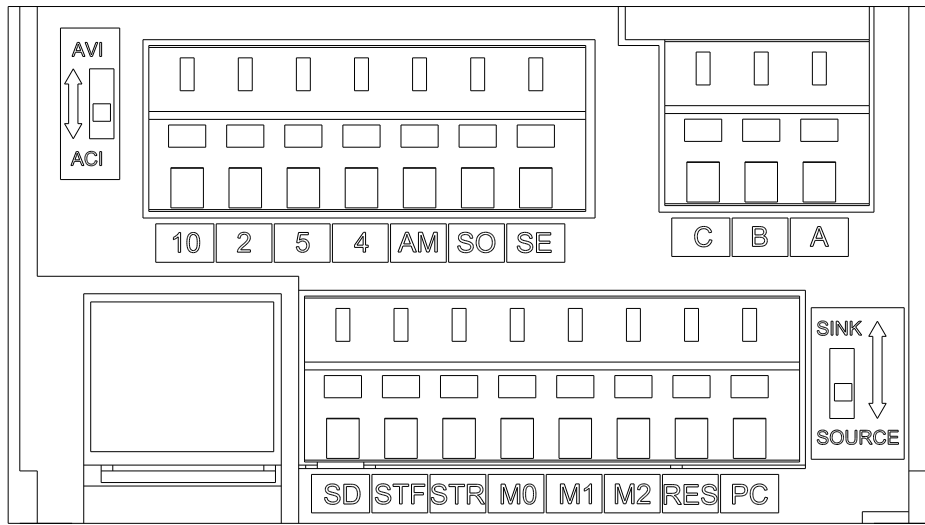

2. The enlarged figure of the main circuit terminal block is as follows:

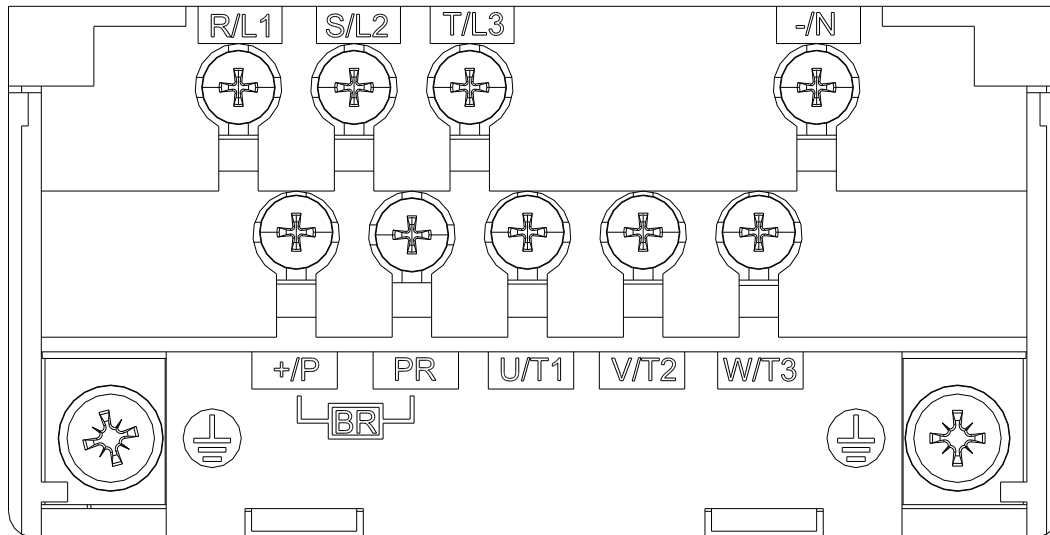

3.5 Installation and Wiring

3.5.1 Transport

Take the pedestal when carrying and don't only take the cover or any part of the inverter, otherwise it may drop down.

3.5.2 Stockpile

This product before installing must be placed in the packaging. If it is not in use, change the frequency to meet the company's warranty scope and future maintenance. Pay attention to the following matters for storage:

1. Must be placed in dry and without dirt place.
2. The environment temperature for storage position must range from -20°C to +65°C.
3. The relative humidity for storage position must range from 0% to 95%, and no condensation.
4. Avoid storing in the environment which contains corrosion gas or liquid.
5. It had better be packed properly and kept on shelf or table.

Note: 1. Even if the humidity meets the standard requirements, icing and condensation can also occur when the temperature changes rapidly. And the place should avoid.

2. Don't place it on the ground, and it should be placed on appropriate shelf. If in the bad surroundings, the desiccant should be placed in the packaging bag.
3. If the custody period is more than 3 months, the ambient temperature should not be higher than 30°C. It is to consider that the character will easily degrade in high temperature when the electrolytic capacitors are deposited without electricity.
4. If the inverter is installed in device or control board when not in use (especially in construction site or the humid and dusty place), the inverter should be removed and put in suitable environment according with the above storage conditions.
5. If the electrolytic capacitors are long-term no electricity, the character will degrade. Do not place it in the state of no electricity for more than one year.

3.5.3 EMC Installation instructions

Inverter is similar to other electrical and electronic equipments. In a power system, an inverter is the electromagnetic interference source and also the electromagnetic receiver. The working principle of inverter determines that it will produce certain electromagnetic interference noise. In order to guarantee the inverter working reliably in the electromagnetic environment, it must have a certain ability of anti-electromagnetic interference in design. In order to make the drive system work normally, and meet CE declared requirements, please meet the following several aspects requirements in installation:

1. Field wiring

Power line supply electric independently from power transformer, five core or four core line are generally used, null line and ground sharing a single line is forbidden.

Commonly signal wire (weak) and power wire (heavy) are in control cabinet, for the inverter, power wire is divided into input line and output line. Signal wire is easily interfered by power wire, so that causing the misoperation of the device. When wiring, signal wire and power wire should be distributed in different areas, parallel lines and interlaced lines are forbidden at close range (within 20cm), and especially don't bundle up the two lines. If the signal cables must pass through the power lines, the two should keep 90 degree Angle. Interlace lines and banding together is also forbidden for the input and output line of power wire, especially on the occasions which noise filter is installed. It will cause the coupling of electromagnetic noise through the distributed capacitance of the input and output lines, thus the noise filter will out of action.

Generally a control cabinet has different electric equipments such as inverter, filter, PLC, measurement instrument, their ability of emitting and bearing electromagnetic noise are diverse from each other, and this requires classifying these equipments. The classification can be divided into strong noise equipment and noise sensitive equipment, Install the similar equipments in the same area and, and keep a distance more than 20cm among inhomogeneous equipments.

2. Input noise filter, input and output magnet ring (zero-phase reactor)

Adding noise filter to the input terminal, the inverter will be isolated from the other equipments, and its ability of conduction and radiation will be reduced effectively. The better EMI suppression effect will be obtained by installing the input reactor recommended by this manual. Increase the ferrite of the input and output terminals (refer to [Section 3.6.5](#)), and at the same time increase the zero-phase reactor (refer to [Section 3.6.5](#)) and 4 turns Hitachi metals nano magnetic ring to reduce the interference in motor side, then can satisfy the limited value of conduction and radiation that is stated by the CE.

3. Shielding

Good shielding and grounding can greatly reduce inverter interference and improve the anti-interference capacity of the inverter. Use the good electricity conducting sheet metal box sealing, the inverter good contacts to metal and let the sheet metal grounded to satisfy the limits value of radiation stated by the CE.

Input and output lines used cable with shielding, good grounding and shielding to satisfy the limits value of radiation stated by the CE.

4. Grounding

The inverter must be connected to the ground safely and reliably. Grounding is not only for equipment and personal safety, but also the simplest, the most efficient and the lowest cost method to solving the EMC problem, so it should be prioritized. Please refer to the section of "terminal wiring".

5. Carrier Wave

The leakage current contains leakage current from line to line or over ground. It depends on the size of distributed capacitance when wiring and carrier frequency of frequency. The higher carrier frequency, longer the motor cable, and larger the cable cross-sectional area is, the larger the leakage current is. Reducing the carrier frequency can effectively reduce the leakage current. When the motor line is long (50m above), the output side should be installed with ac reactor or sine wave filter, when the motor line is longer, a reactor should be installed every other distance. At the same time, reducing carrier frequency can effectively reduce the conduction and radiation interference, and the limits value of the conduction and radiation which CE declared can be met in 5K carrier frequency.

3.5.4 Installation notice

It is recommended that when installing the inverter, it must be far away from heat and radiation sources that can damage the inverter.

✓ Before installation, please confirm whether meet the conditions listed in the table below:

Ambient temperature	-10 ~ +50°C (non-freezing), installation side by side -10~ +40°C.
Ambient humidity	Below 90%Rh (non-condensing)
Storage temperature	-20 ~ +65°C
Operating environment	Indoor, no corrosive gas, no flammable gas, no flammable dust
Altitude and vibration	Altitude below 1000 meters, Vibration below 5.9m/s ² (0.6G).
Grade of protection	IP20
The degree of environmental pollution	2
Class of protection	Class I

1. Please install in an upright direction.

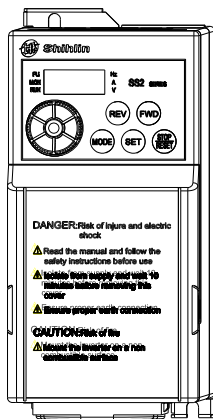

2. Clear the surroundings when installing.

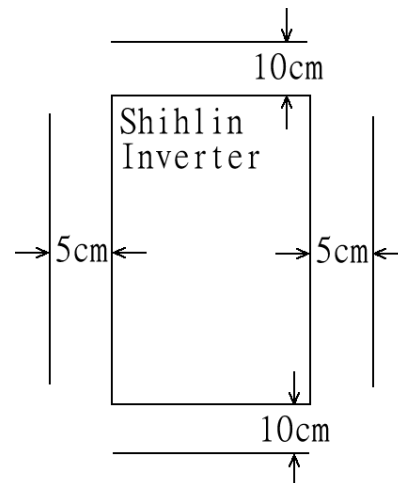

3. The ambient temperature shall not exceed the permissible value.

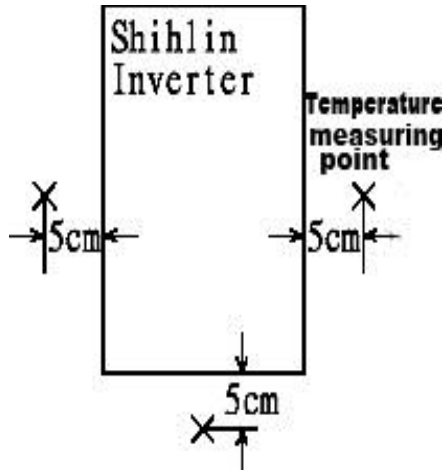

4. Install inverters in a protection case correctly.

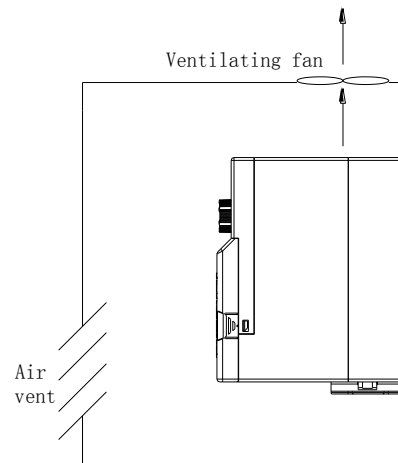

5. Do not install the inverter on a surface of inflammable material such as wood.

6. Do not install the inverter at place exposed to explosive gas or inflammable dust.

7. Do not install the inverter at place with airborne oil mist and dust.

8. Do not install the inverter at place exposed to corrosive gas or high salt air.

9. Do not install the inverter in the environment of high temperature and high humidity.

10. Please refer to the installation method as follows.

Orbit determination installation:

1. Orbit determination installation

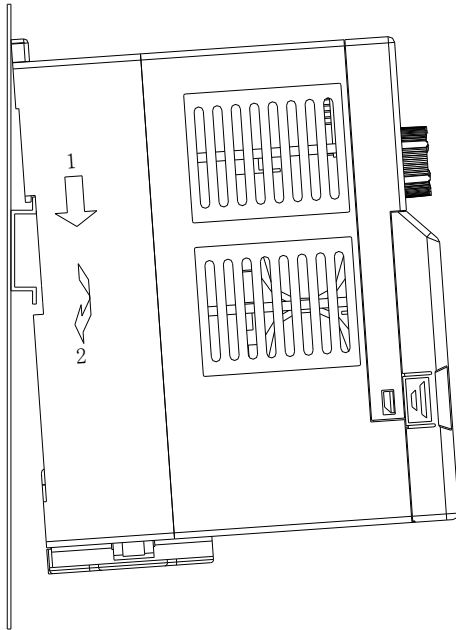

2. Orbit determination removes

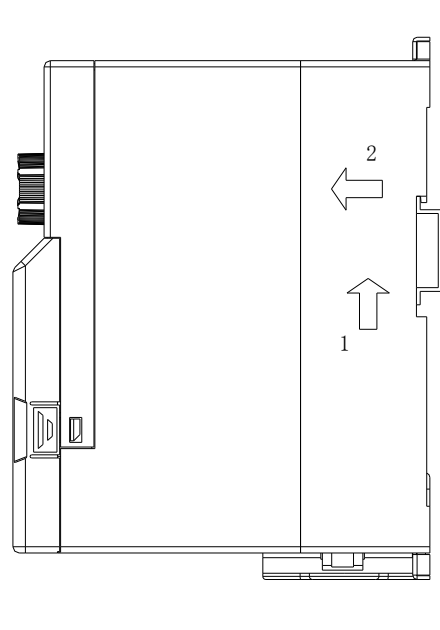

3. Orbit determination installation side by side

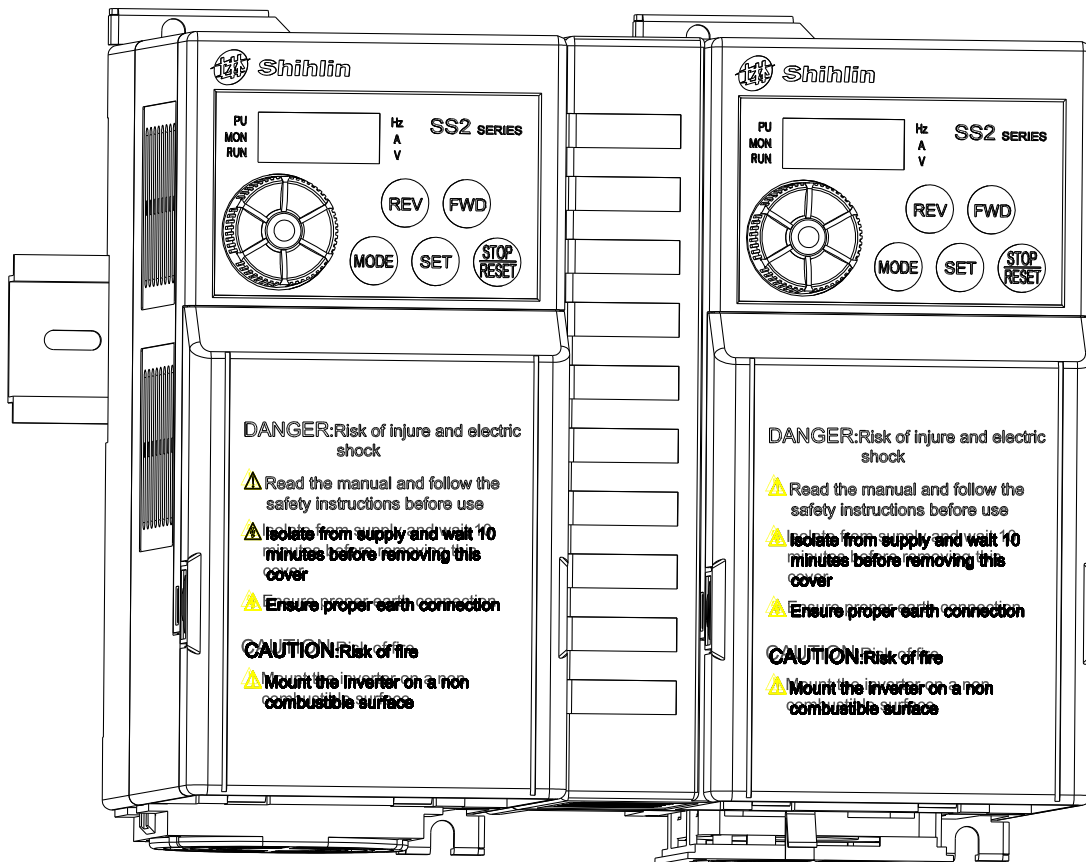

Installation with screws:

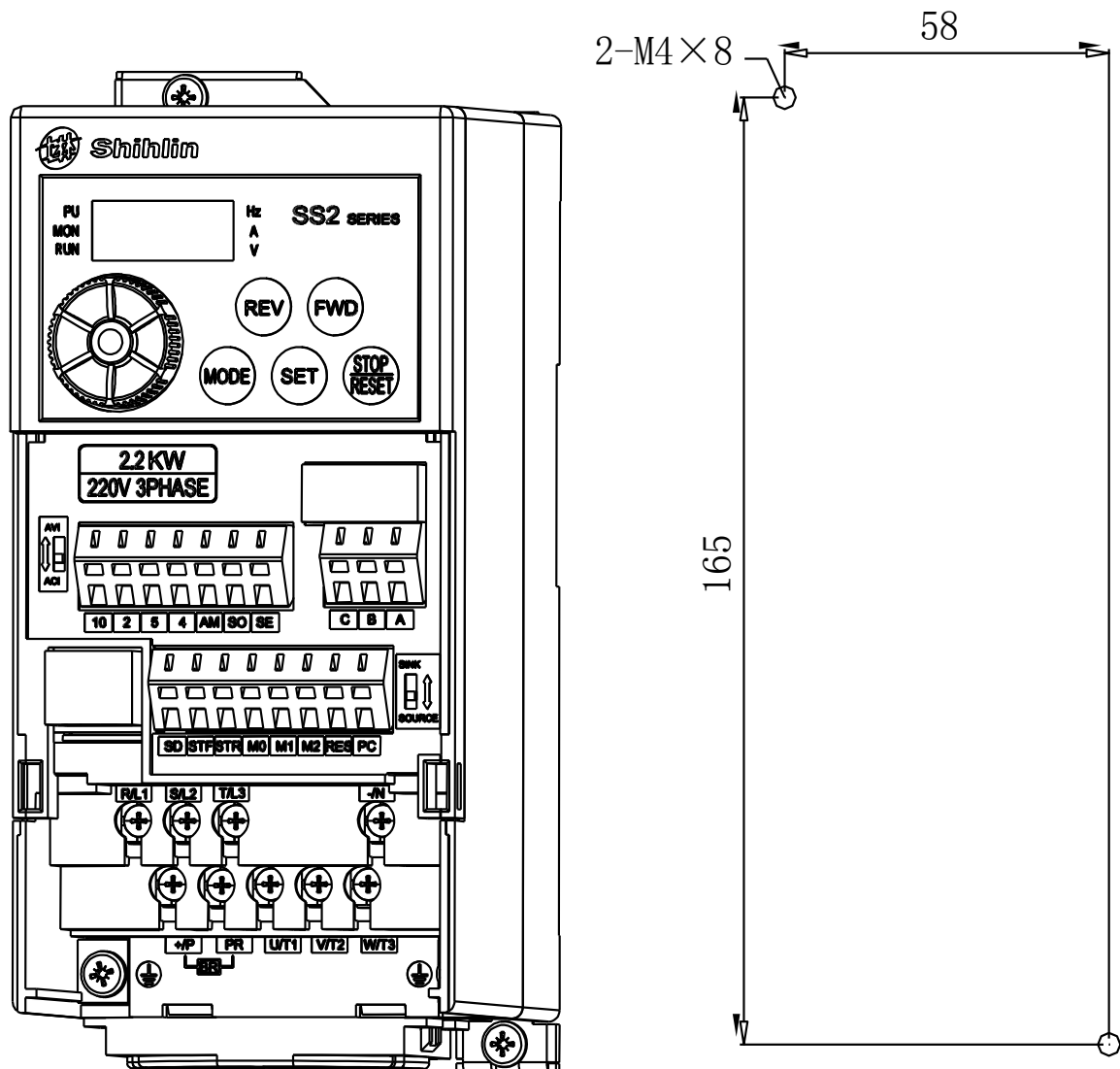

Note: 1. Please choose the screw size M4.

2. Carry out the installation, wire arrangement, dismounting and maintenance by qualified electrical professional personnel.

3. Follow the installation notice. In case the installation notice has not been fully complied with and damage of the inverter or dangerous accident thus be resulted in, our company will not undertake any legal responsibility. In case there is any question when installing, please feel free to contact us.

3.5.5 System wire arrangement

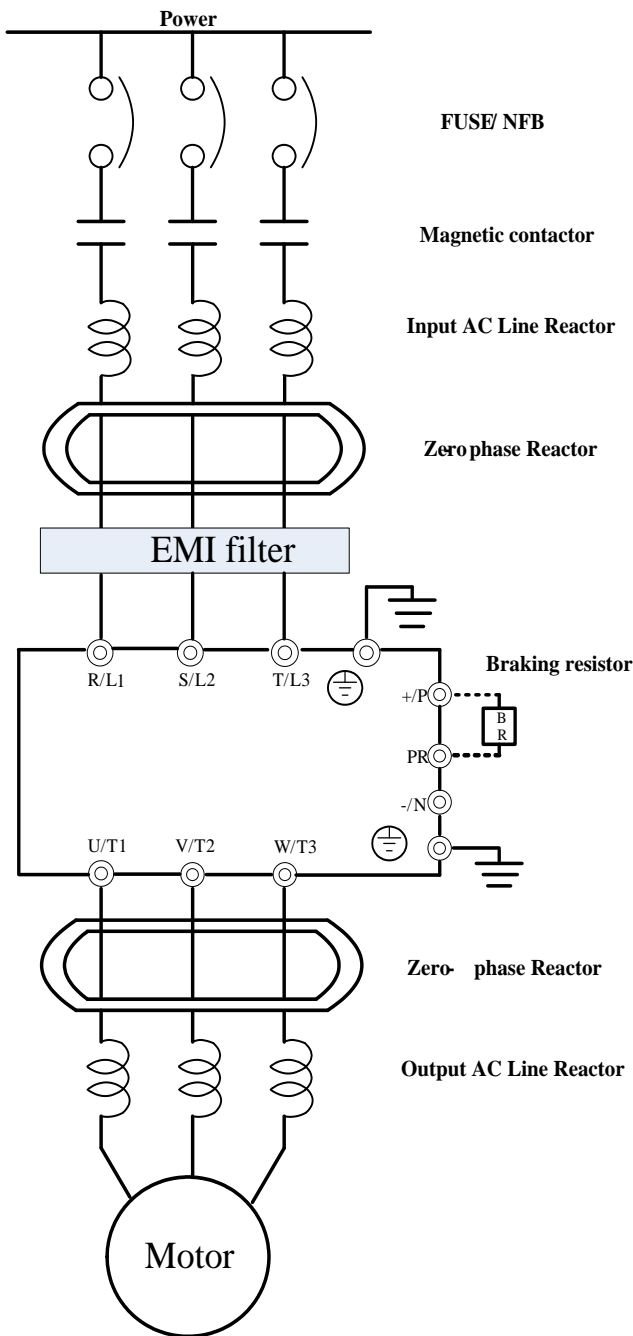

Power supply	Please follow the specific power supply requirement shown in this manual.
Fuse/NFB	There may be an inrush current during power up. Please refer to 3.6.1 and select the correct fuse /NFB.
Magnetic contactor	Please do not use a Magnetic contactor as the I/O switch of the inverter, as it will reduce the operating life cycle of the inverter.
Input AC Line Reactor	AC line reactor should be installed to improve the input power factor. The wiring distance should be less than 10m. Please refer to 3.6.6.
Zero-phase Reactor	Zero-phase reactors are used to reduce radio noise especially when audio equipment installed near the inverter. Effective for noise reduction on both the input and output sides. Attenuation quality is good for a wide range from AM band to 10MHz. Please refer to 3.6.5.
EMI filter	Used to reduce electromagnetic interference.
Braking unit	Used to reduce stopping time of the motor.
Output AC Line Reactor	Motor surge voltage amplitudes depending on motor cable length. The output AC line reactor is necessary to install on the inverter output side. Please refer to 3.6.6.

3.5.6 Terminal wire arrangement

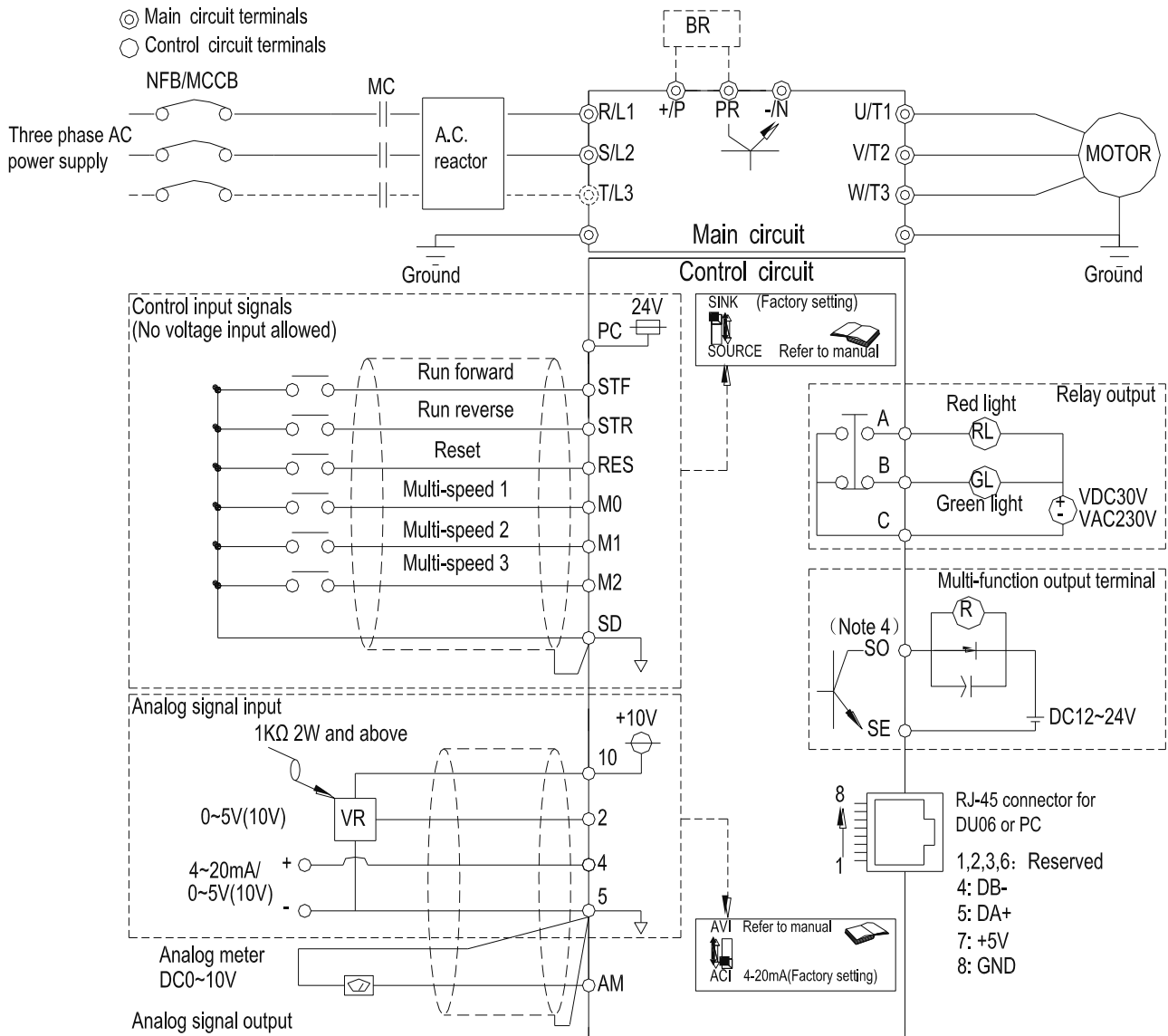

==== Note: =====

1. For the usage of the external thermal relay, please refer to P.80~P.84, P.86 in Chapter 5.
 2. Make sure not to short circuit the PC and SD.
 3. In the above figure, Dotted line metal, please refer to 3.5.7
 4. The SO terminal can select to FM or 10X function, please refer to P.64, P.74.
 5. For single-phase series inverters, there is no T/L3 terminal, and the corresponding wiring(dotted line) doesn't need to be connected.
- =====

Note: 1. For multi-function control terminals, please refer to P.80~P.84, P.86, and for multi-function output terminals, please refer to P.40 in Chapter 5.

2. For SS2-TYPE series inverters, the multi-function control terminals have both the sink input mode and the source input mode. There is a jumper that can be used to alternate between those two modes. If the jumper is on the left side, the sink input mode is chosen, while the source input mode is chosen if the jumper is on the right side. Shown as follows:

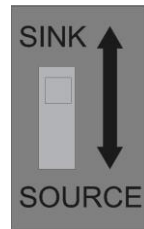

Sink Input

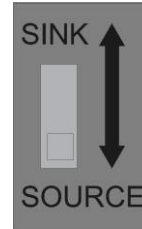

Source Input

No matter what kind of multi-function control terminal is used, all of its outside wire arrangement can be considered as a simple switch. If the switch is 'on', the control signal will be put into the terminal. If the switch is 'off'; the control signal is shut off.

If the sink input mode is selected, the function of the terminal is active when it is shorted with SD or connected to the external PLC. At this mode, the current flows out of the corresponding terminal when it is 'on'. Terminal SD is common the contact input signals. When using an external power supply for transistor, please use terminal PC as a common to prevent malfunction caused by leakage current.

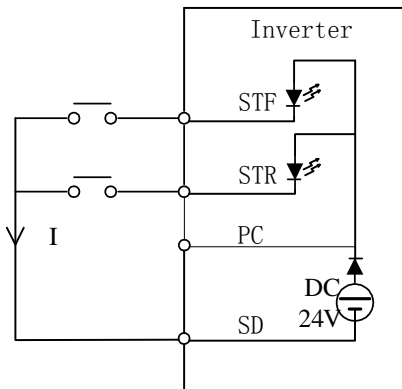

Sink Input: the multi-function control terminal is shorted directly with SD

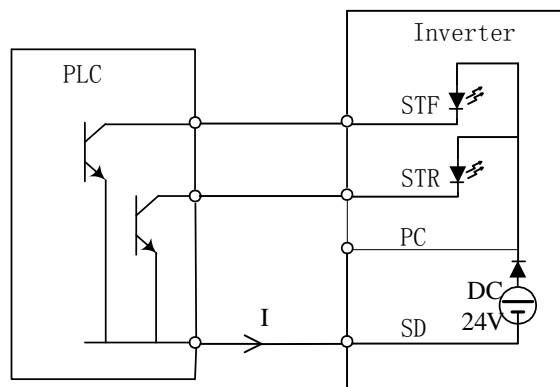

Sink Input: the multi-function control terminal is connected directly with open-collector PLC

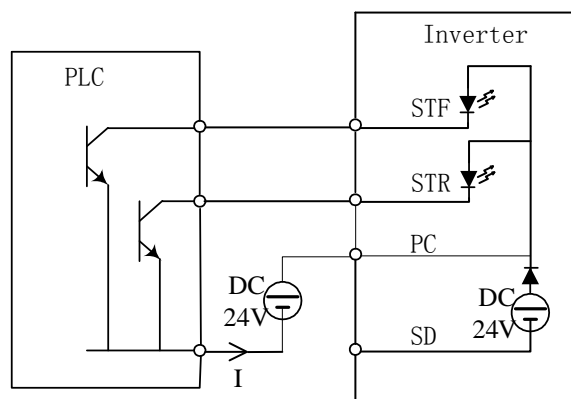

Sink Input: the multi-function control terminal is connected with open-collector PLC and external power supply

If the source input mode is selected, the function of the multi-function control terminal is active when it is shorted with PC or connected with the external PLC. At this mode, the current flows into the corresponding terminal when it is 'on'. Terminal PC is common to the contact input signals. When using an external power supply for transistor output, please use terminal SD as a common to prevent malfunction caused by leakage current.

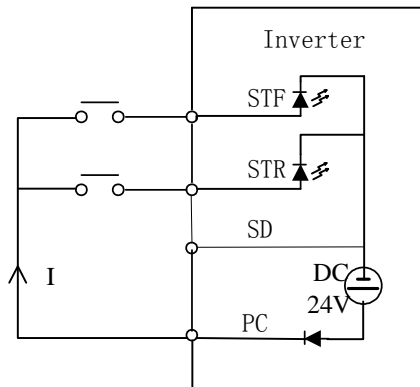

Source Input: the multi-function control terminal is shorted directly with PC

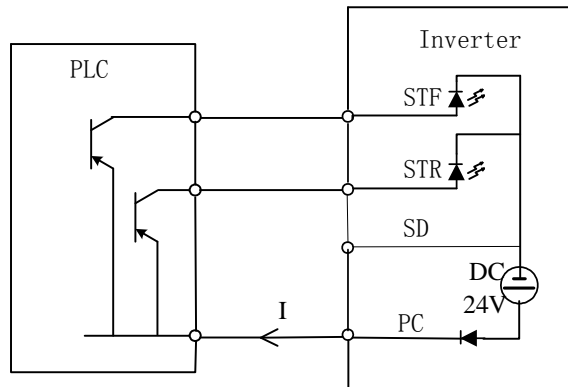

Source Input: the multi-function control terminal is connected directly with open-emitter PLC

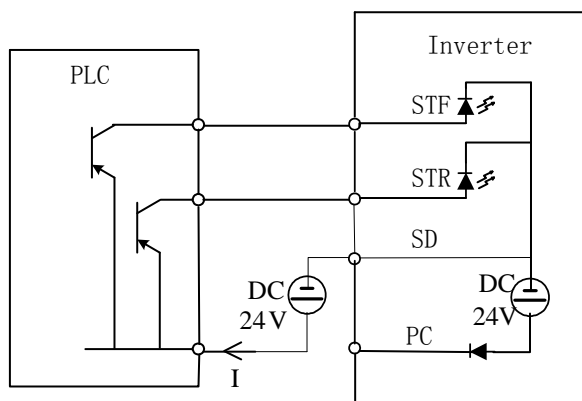

Source Input: the multi-function control terminal is connected with open-emitter PLC and external power supply

Main-circuit terminals

Terminal name	Remarks
R/L1- S/L2- T/L3	Connect to the commercial power supply.
U/T1-V/T2-W/T3	Connect to three-phase squirrel-cage motor.
+P- PR	Connect to braking resistors. (Note1, 2)
(+P)-(-N)	Connect to braking unit. (Note3)
	Connect the enclosure of the inverter to ground. For 220V series, the third type of grounding shall be adopted. For 440V series, special type of grounding shall be adopted. (Note 4)

- Note: 1. For SS2-TYPE series of inverters, brake resistor is not included. For information related to braking resistor, please refer to 3.6.3.
2. For information related to regenerative voltage, please refer to P.30 in Chapter 5.
3. +/P and -/N are the positive and negative terminals of the internal DC voltage of the inverter. In order to strengthen the braking capability during deceleration, it is suggested to purchase an optional brake unit to be mounted between terminals +/P and -/N. The brake unit can effectively dissipate the feedback energy from the motor to the inverter when decelerating. In case there is any problem on purchasing the brake unit, please feel free to contact us.
4. For safety and noise reduction, grounding terminals of inverter must to be well grounded. To avoid electric shocks and fire accidents, external metal wire of electrical equipment should be short and thick, and it should be connected to the special grounding terminals of inverter. If many of the inverters are placed together, all inverters must be connected to the common ground. Please refer to the following diagram and do not form s circuit between the grounding terminals.

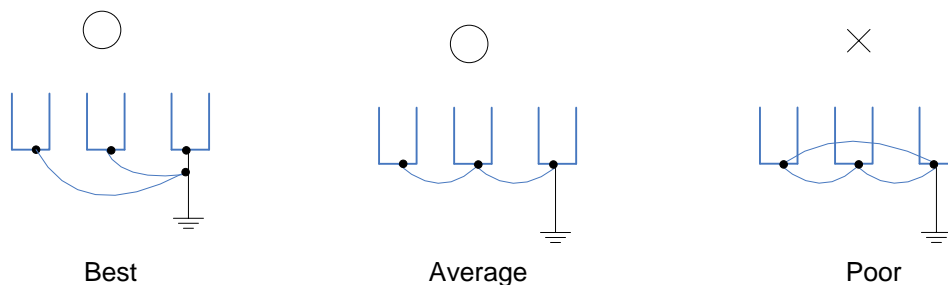

Control terminals			
Terminal Type	Terminal Name	Function Name	Remarks and Function Description
On-off Signal Input	STF	Optional	These terminals are multi-function control terminals (SINK/SOURCE mode switchable). For detailed descriptions, please refer to <u>P.80~P.84, P.86</u> in Chapter 5.
	STR	Optional	
	M0	Optional	
	M1	Optional	
	M2	Optional	
	RES	Optional	
	SD	SD	Common reference ground for STF, STR, M0, M1, M2 and RES
	PC	PC	In the 'Source input' mode, it provides a common DC24V power supply which Allow load current 50 mA for the terminals referred to above.
Analog Signal Input	10	---	The internal power is DC 10V at this terminal which Allow load current 5 mA
	2	---	The input of voltage signal 0~5V or 0~10V, is used to set the target frequency. <u>P.38</u>
	4	---	The input of voltage signal 0~5V or 0~10V/input of current signal 4mA~20mA (switch with <u>P.17</u>), is used to set the target frequency. (Note 1) <u>P.39</u>
	5	---	The common reference ground of 2, 4, 10 and AM.
Relay Output	A	---	Normally, A-C are normal open, and B-C are normal closed. Contact capacity is VDC30V / VAC230V-0.3A
	B	---	
	C	---	
Open Collector Output	SO	Optional	The terminal can also be called a multi-function output terminal; contact capacity is VDC24V-0.1A. The function name can be set by <u>P.40</u> . For detailed description, please refer to <u>P.40</u> in Chapter 5.
	SE	SE	Open collector output reference ground.
Analog Signal Output	AM	---	Connected with an external analog meter to indicate the output frequency or current. Contact capacity is 0~10VDC/2mA. Please refer to <u>P.54, P.55, P.56, P.191, and P.192</u> in Chapter 5.
Communication Terminal	RJ45	---	Connector for inverters communication with DU06 , PC or PLC.

3.5.7 Wiring precautions

Main circuit wiring:

1. Do not connect the power supply wires to the inverter output terminals U/T1-V/T2-W/T3 that are designed for connecting motors; otherwise, the inverter may be damaged.
2. Please do not mount filtering capacitors, surge absorbers and electromagnetic contactors at the output end of the inverter.

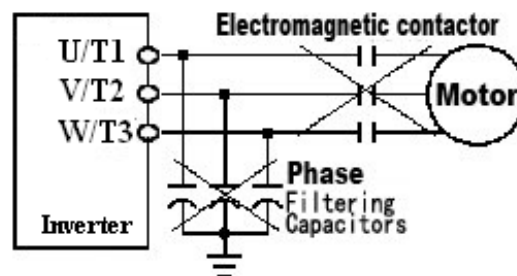

3. Please do not use electromagnetic contactors or no-fuse switches with an online power to start or stop the motor.
4. Please ensure that the case of inverter and the motor are grounded to avoid electric shock.
5. To appropriately select the diameter of the main wires and the corresponding wire terminals, the no-fuse switches and the electromagnetic contactors, please refer to [Section 3.6](#). And if the inverter is far away from the motor, please employ a wire with larger diameter to ensure the voltage drop along the wire is within 2V. (The total length of the wire shall not exceed 500 meters)
6. Pressing connection terminals with insulated sleeve shall be utilized for the wiring at the power source side and the loading side.
7. High voltage still exists between the (+/P)-(-/N) terminals shortly after shutting off the power supply, thus please do not touch them within 10 minutes after the shut off to avoid electric shock.

Control circuit wire arrangement:

1. For wiring of signal input, insulated wires must be used, and the metal mesh of which must be grounded.
2. For wiring of the control board, wire with a diameter of 0.3~0.75 mm² is recommended. For stripping off the insulating layer please follows the instruction of the following figure.

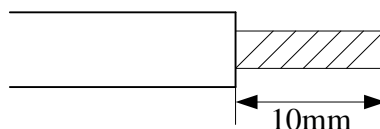

3. The control board wire (including signal input wire) shall be away from the main circuit board wire as much as possible. Binding the control board wire together with the main circuit wire is strictly forbidden.
4. In the inverter, terminal SD, terminal SE and the terminal 5 are the reference grounds for the inner power sources isolated from each other.

5. Wiring installation

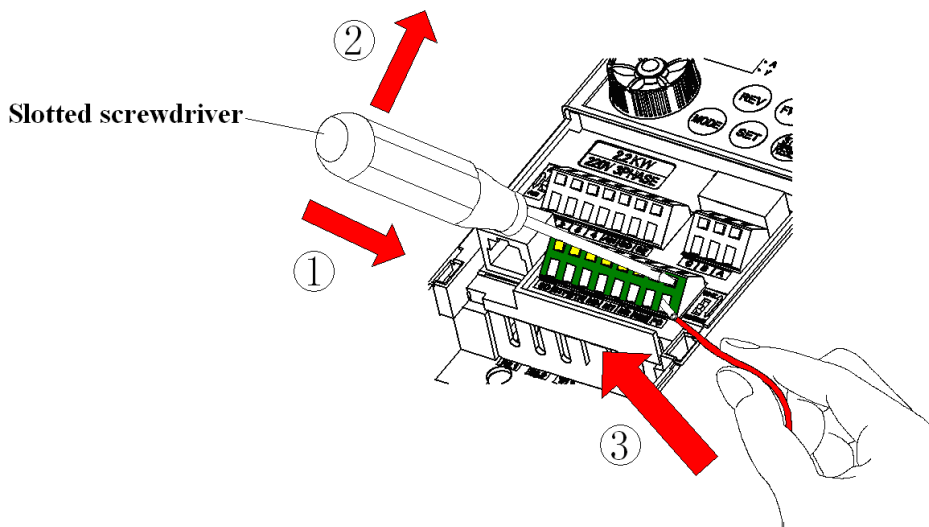

First insert slotted screwdriver with terminal blocks, pressing terminal blocks down, and then insert the electric wires.

6. Wiring demounting

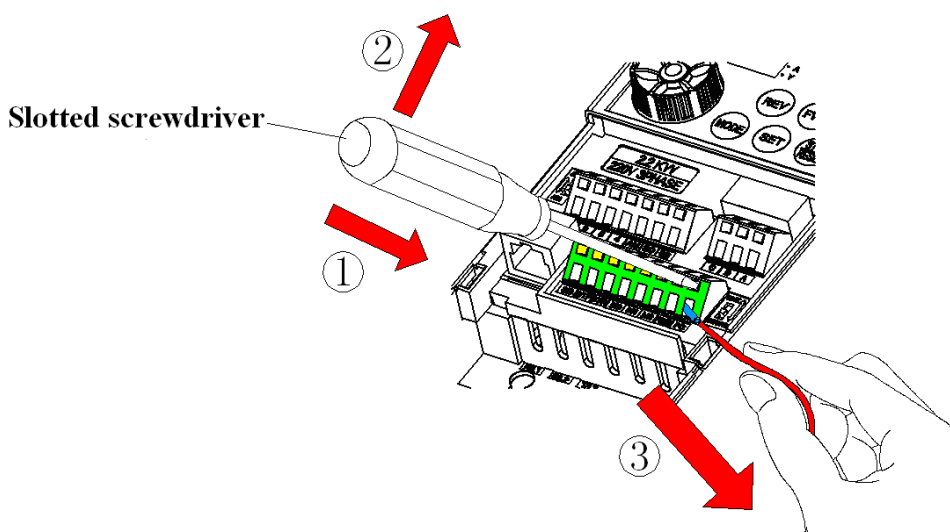

First insert slotted screwdriver with terminal blocks, and pressing terminal blocks down, and then pull out the wire.

Note: 1. Screwdriver, use small slotted screwdriver (the tip thickness: 0.4mm/tip width: 2.5mm).

2. If you use the screwdriver tip width too narrow, and may cause Terminal damage.

3. Please alignment terminals pressing down with the slotted screwdriver, head of the sliding may cause damage or injury accident inverter.

4. Only qualified electrical professional personnel can carry out the installation, wire arrangement, dismounting and maintenance.

5. Please follow the wire arrangement notice. In case the installation has not been fully complied with, and damage of the inverter or dangerous accident thus be resulted in, our company will not undertake any legal responsibility. In case there is any question on the wire arrangement, please feel free to contact us.

3.6 Selection of Peripheral Equipments

3.6.1 No-fuse switch

Inverter Type	Motor Capacity	Power Source Capacity	Applicable NFB/MCCB Type (Shihlin)	Applicable MC Type (Shihlin)
SS2-021-0.4K	220V 0.5HP	1.5kVA	BM30SN3P5A	S-P11
SS2-021-0.75K	220V 1HP	2.5kVA	BM30SN3P10A	S-P11
SS2-021-1.5K	220V 2HP	3.5kVA	BM30SN3P15A	S-P11
SS2-021-2.2K	220V 3HP	6.4kVA	BM30SN3P20A	S-P11/ S-P12
SS2-023-0.4K	220V 0.5HP	1.5kVA	BM30SN3P5A	S-P11
SS2-023-0.75K	220V 1HP	2.5kVA	BM30SN3P10A	S-P11
SS2-023-1.5K	220V 2HP	4.5kVA	BM30SN3P15A	S-P11
SS2-023-2.2K	220V 3HP	6.4kVA	BM30SN3P20A	S-P11 / S-P12
SS2-023-3.7K	220V 5HP	10kVA	BM30SN3P30A	S-P21
SS2-043-0.4K	440V 0.5HP	1.5kVA	BM30SN3P3A	S-P11
SS2-043-0.75K	440V 1HP	2.5kVA	BM30SN3P5A	S-P11
SS2-043-1.5K	440V 2HP	4.5kVA	BM30SN3P10A	S-P11
SS2-043-2.2K	440V 3HP	6.9kVA	BM30SN3P15A	S-P21
SS2-043-3.7K	440V 5HP	10.4kVA	BM30SN3P20A	S-P21
SS2-043-5.5K	440V 7.5HP	13.8kVA	BM30SN3P30A	S-P21

3.6.2 Power cable specification/pressing connection terminals specification

Inverter Type	Power Cable Specification (PVC cables standard)				Pressing connection terminal specification (used by power cables)	
	Power supply terminal (R/L1- S/L2- T/L3)		Loading terminal (U/T1-V/T2-W/T3)		Power supply terminal	Loading terminal
	Crimping terminal (mm ²)	Tightening torque (Kgf.cm)	Crimping terminal (mm ²)	Tightening torque (Kgf.cm)		
SS2-021-0.4K	2.5	12.2	2.5	12.2	2-3.5	2-3.5
SS2-021-0.75K	2.5	12.2	2.5	12.2	2-3.5	2-3.5
SS2-021-1.5K	2.5	18	2.5	18	2-4	2-4
SS2-021-2.2K	4	18	4	18	5.5-4	2-4
SS2-023-0.4K	2.5	12.2	2.5	12.2	2-3.5	2-3.5
SS2-023-0.75K	2.5	12.2	2.5	12.2	2-3.5	2-3.5
SS2-023-1.5K	2.5	12.2	2.5	12.2	2-3.5	2-3.5
SS2-023-2.2K	4	18	2.5	18	3.5-4	2-4
SS2-023-3.7K	4	18	4	18	5.5-4	5.5-4
SS2-043-0.4K	2.5	12.2	2.5	12.2	2-3.5	2-3.5
SS2-043-0.75K	2.5	12.2	2.5	12.2	2-3.5	2-3.5
SS2-043-1.5K	2.5	12.2	2.5	12.2	2-3.5	2-3.5
SS2-043-2.2K	2.5	18	2.5	18	2-4	2-4
SS2-043-3.7K	2.5	18	2.5	18	2-4	2-4
SS2-043-5.5K	4	18	2.5	18	5.5-4	2-4

3.6.3 Brake resistors

Voltage	Motor (KW)	Braking Unit		Braking Resistor (10%ED, Braking Torque 125%)			Maximum braking torque limit		
		Model	QTY	Model	QTY	Resistor specifications	Minimum resistance value(Ω)	The highest total braking current (A)	Maximum peak power (KW)
021	0.4	--	--			40W 375 Ω	220	2	0.6
	0.75	--	--			75W 200 Ω	120	3	1.1
	1.5	--	--			150W 100 Ω	60	6	2.2
	2.2	--	--			220W 68.2 Ω	60	6	2.2
023	0.75	--	--			75W 200 Ω	120	3	1.1
	1.5	--	--			150W 100 Ω	60	6	2.2
	2.2	--	--			220W 68.2 Ω	60	6	2.2
	3.7	--	--			370W 40.5 Ω	40	9	3.2
043	0.75	--	--			75W 800 Ω	800	1	0.7
	1.5	--	--			150W 400 Ω	320	2	1.6
	2.2	--	--			220W 272.8 Ω	160	5	3.2
	3.7	--	--			370W 162.2 Ω	120	6	4.3
	5.5	--	--			550W 109.1 Ω	75	10	6.9

Note: 1. The brake resistor capacity listed in the above table is based on a 10% regenerative brake duty (that is, in case braking lasts for 5 seconds, another 45 seconds must be provided for heat dissipation). The brake resistor wattage can be reduced according to the user's application (quantity of heat) and the regenerative brake duty. But the resistance must be larger than the value list in the above table (otherwise damage of the inverter thus be resulted in).

2. In case frequent start and stop operations are required, a larger regenerative brake duty should be set; meanwhile, a larger brake resistor should be employed correspondingly. If there is any problem about selection of brake resistors, please feel free to contact us.

To prevent the braking resistor from overheating or burning out when the brake unit is damaged, it is recommended to use the sequence control program shown in the figure below.

Example 1:

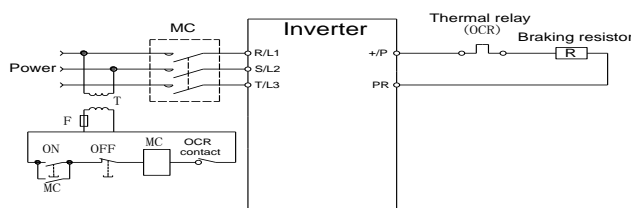

Example 2:

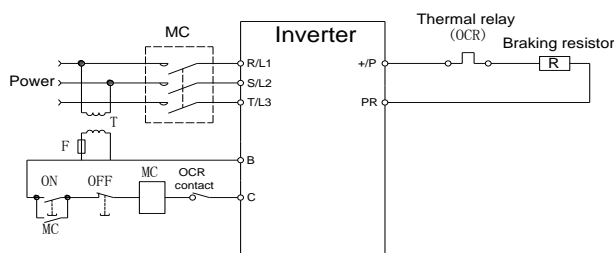

3.6.4 EMI filter

Inverter Type	DUOJI Filter Type	Inverter Type	DUOJI Filter Type
SS2-021-0.4K	NF211B10/01	SS2-043-0.4K	NF311A10/01
SS2-021-0.75K		SS2-043-0.75K	
SS2-021-1.5K	NF241B20/05	SS2-043-1.5K	
SS2-021-2.2K	NF241B30/25	SS2-043-2.2K	NF311A20/05
SS2-023-0.4K	NF311A10/01	SS2-043-3.7K	
SS2-023-0.75K		SS2-043-5.5K	
SS2-023-1.5K			
SS2-023-2.2K	NF311A20/05		
SS2-023-3.7K			

Note: Products of CHANGZHOU DUOJI EME TECHNICAL CO., LTD are recommended for the filter used here.

3.6.5 Zero-phase reactor

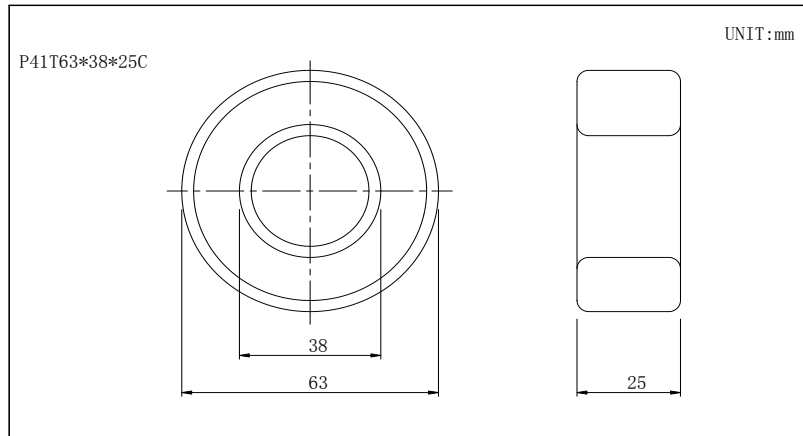

Inverter Type	Motor Capacity		Qty.	Recommended Wire Size (mm ²)	Wiring Method
	HP	kW			
220V Single- phase	1/2	0.4	1	0.5-5.5	Diagram A
	1	0.75			
	2	1.5	2	3.5-5.5	
	3	2.2			
220V Three- phase	1/2	0.4	1	0.5-5.5	
	1	0.75			
	2	1.5	2	3.5-5.5	
	3	2.2			
	5	3.7			
440V Three-phase	1/2	0.4	1	0.5-5.5	
	1	0.75			
	2	1.5	2	3.5-5.5	
	3	2.2			
	5	3.7			
	7.5	5.5			

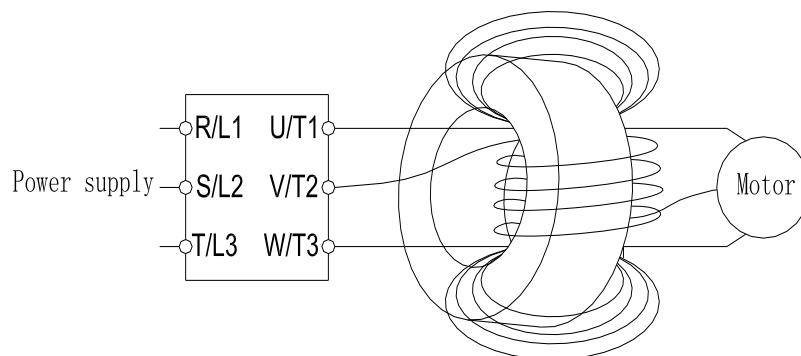

Diagram A: Please wind each four times around the core and around the same.

3.6.6 Input/output reactor

Input AC Line Reactor

220V, 50/60Hz, Three-phase

kW	Rated Amps of Inverter	2% Impedance Reactor Types	4% Impedance Reactor Types
0.4	3	ACL-0005-EISC-E3M8	ACL-0005-EISC-E5M6
0.75	5	ACL-0005-EISC-E3M8	ACL-0005-EISC-E5M6
1.5	8	ACL-0010-EISC-E1M5	ACL-0010-EISC-E2M8
2.2	11	ACL-0015-EISC-E1M0	ACL-0015-EISC-E1M9
3.7	17.5	ACL-0020-EISC-EM75	ACL-0020-EISC-E1M4

440V, 50/60Hz, Three-phase

kW	Rated Amps of Inverter	2% Impedance Reactor Types	4% Impedance Reactor Types
0.4	1.5	ACL-0005-EISC-E3M8	ACL-0005-EISC-E5M6
0.75	2.6	ACL-0005-EISC-E3M8	ACL-0005-EISC-E5M6
1.5	4.2	ACL-0005-EISC-E3M8	ACL-0005-EISC-E5M6
2.2	6	ACL-0007-EISC-E2M5	ACL-0007-EISC-E3M5
3.7	9	ACL-0010-EISC-E1M5	ACL-0010-EISC-E2M8
5.5	12	ACL-0015-EISC-E1M0	ACL-0015-EISC-E1M9

Output AC Line Reactor

220V, 50/60Hz, Single-phase

kW	Rated Amps of Inverter	1% Impedance Reactor Types	2% Impedance Reactor Types
0.4	2.7	OCL-0005-EISC-E1M4	OCL-0005-EISC-E2M8
0.75	4.5	OCL-0005-EISC-E1M4	OCL-0005-EISC-E2M8
1.5	8	OCL-0010-EISC-EM70	OCL-0010-EISC-E1M4
2.2	11	OCL-0015-EISC-EM47	OCL-0015-EISC-EM93

Introduction of Shihlin Inverter

Selection of Peripheral Equipments

220V, 50/60Hz, Three-phase

kW	Rated Amps of Inverter	1% Impedance Reactor Types	2% Impedance Reactor Types
0.4	3	OCL-0005-EISC-E1M4	OCL-0005-EISC-E2M8
0.75	5	OCL-0005-EISC-E1M4	OCL-0005-EISC-E2M8
1.5	8	OCL-0010-EISC-EM70	OCL-0010-EISC- E1M4
2.2	11	OCL -0015-EISC-EM47	OCL -0015-EISC-EM93
3.7	17.5	OCL -0020-EISC-EM35	OCL -0020-EISC-EM70

440V, 50/60Hz, Three-phase





kW	Rated Amps of Inverter	1% Impedance Reactor Types	2% Impedance Reactor Types
0.4	1.5	OCL-0005-EISC-E1M4	OCL-0005-EISC-E2M8
0.75	2.6	OCL-0005-EISC-E1M4	OCL-0005-EISC-E2M8
1.5	4.2	OCL-0005-EISC-E1M4	OCL-0005-EISC-E2M8
2.2	6	OCL-0007-EISC-E1M0	OCL-0007-EISC-E1M9
3.7	9	OCL-0010-EISC-EM70	OCL-0010-EISC- E1M4
5.5	12	OCL -0015-EISC-EM47	OCL -0015-EISC-EM93

Note: It is recommended to use the AC input / output reactor which produced by SHANGHAI EAGTOP ELECTRONIC TECHNOLOGY CO., LTD.

4. Primary Operation



4.1 Operation Modes of the Inverter

- The operation modes are related to the **reference source of the target frequency** and the **signal source of the motor starting**. Shihlin SS2-TYPE inverter has a total of 9 kinds of operation modes, namely, **PU mode**, **JOG mode**, **external mode**, **communication mode**, **combined mode 1**, **combined mode 2**, **combined mode 3**, **combined mode 4** and **combined mode 5**.
- The operation panel can be used to monitor the output frequency, output current, and output voltage, and to browse the alarming information, set parameters and target frequency, etc. Therefore, there are totally five working modes for an operation panel: **operating mode**, **monitoring mode**, **frequency setting mode**, **parameter setting mode**, and **HELP mode**.

Related Parameters	Values	Operation Mode	Reference Source of Target Frequency	Signal Source of Motor Starting	Remarks
Operation Mode Selection P.79	0	PU mode (<i>PU</i>)	operation panel	Press the key  or  on the operation panel	The PU mode, external mode and JOG mode are valid and interchangeable.
		JOG mode (<i>JOG</i>)	The set value of P.15	Press the key  or  on the operation panel	
		External mode (<i>SPnd</i>)	External voltage/current signal, combination of multi-speed stage levels or External JOG	External terminals	
			Frequency set by pulse (P.82)		
		Frequency of each section in Programmed operation mode (P.131~P.138)	External terminal STF		
	1	PU mode (<i>PU</i>)	Equal to the PU mode when P.79=0		The 'PU mode' and 'JOG mode' are valid and interchangeable.
		JOG mode (<i>JOG</i>)	Equal to the JOG mode when P.79=0		
	2	External mode (<i>SPnd</i>)	Equal to the External mode when P.79=0		
	3	Communication mode (<i>CU</i>)	Communication	Communication	(Note)

Primary Operation

Operation Modes of the Inverter

Related Parameters	Values	Operation Mode	Reference Source of Target Frequency	Signal Source of Motor Starting	Remarks
Operation Mode Selection P.79	4	Combined mode 1 (H1)	operation panel	External terminals	
	5	Combined mode 2 (H2)	External voltage/current signal, combination of multi-speed stage levels or frequency set by pulse (P.82)	Press the key  or  on the operation panel.	
	6	Combined mode 3 (H3)	Communication, combination of multi-speed stage levels or External JOG (P.15)	External terminals	(Note)
	7	Combined mode 4 (H4)	External voltage/current signal, combination of multi-speed stage levels or frequency set by pulse (P.82)	Communication	
	8	Combined mode 5 (H5)	Operation panel, combination of multi-speed stage levels or external JOG(P.15)	External terminals	

Note: If P.79=0, the inverter is in the external mode (*Opnd*) when starting, and the operating mode can be shifted by setting P.79.

4.1.1 The flow chart for transferring operation modes with operation panel

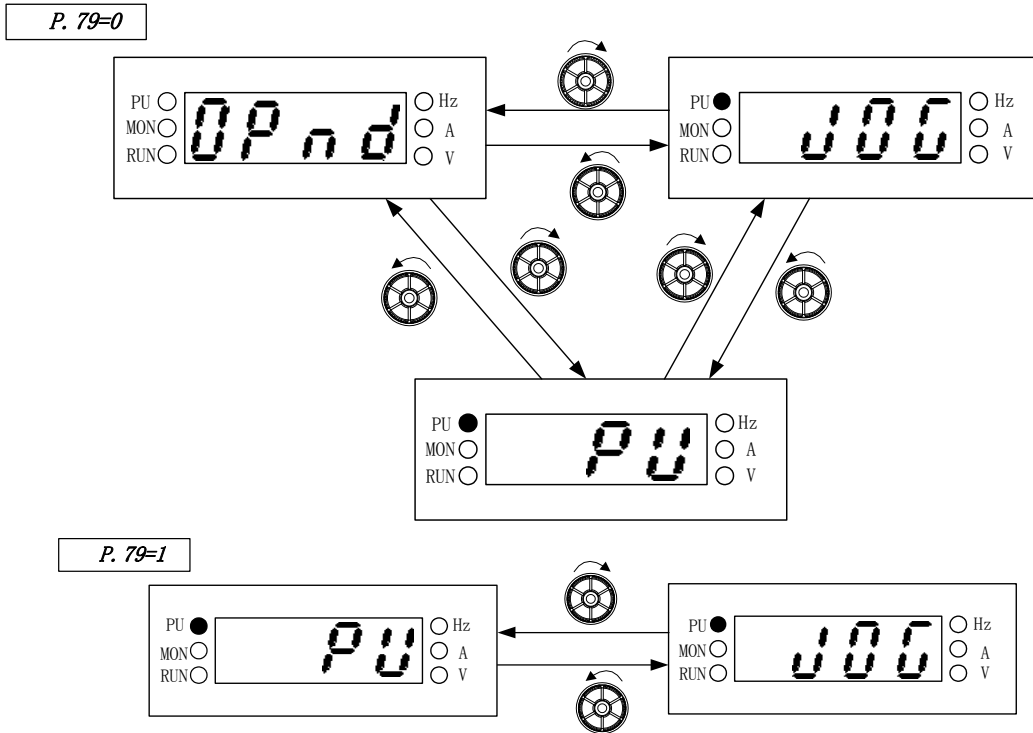

Note: 1. At the PU mode, the indicating lamp **PU** ● in the operation panel will be lit up.
 2. At the external mode, the display screen will display *OPnd*
 3. At the combined mode 1, 2, 3, 4 or 5, the indicating lamp **PU** ● will flicker.
 4. At the JOG mode, the indicating lamp **PU** ● will be lit up, and at the same time the display screen will display *JOG* while the motor is not running.
 5. The operation mode will be constant if P.79 is equal to 2, 3, 4, 5, 6, 7 or 8, so there are no flow charts for it.

4.1.2 The flow chart for transferring working modes with operation panel

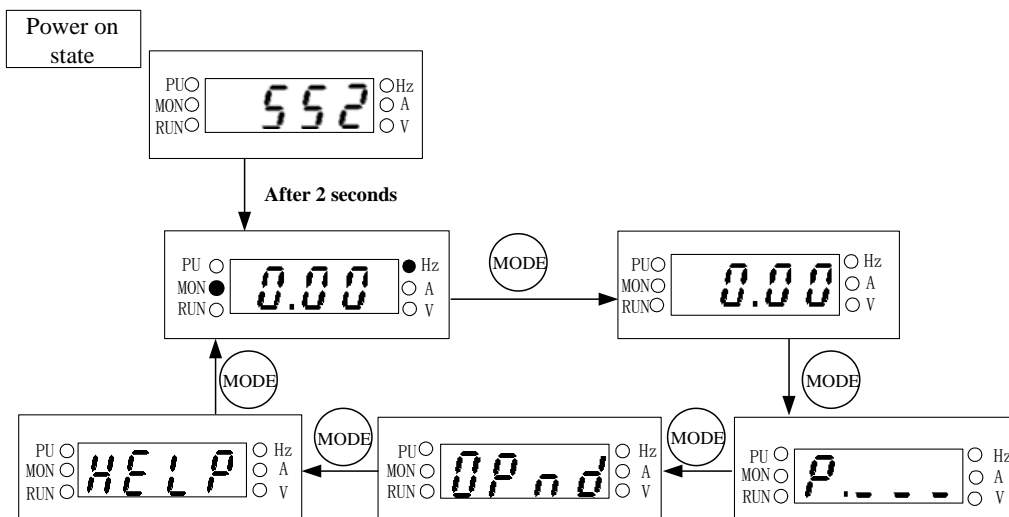

- Note: 1. For detailed operating flow at monitoring mode, please refer to Section 4.1.3.
 2. For detailed operating flow at frequency setting mode, please refer to Section 4.1.4.
 3. For detailed operating flow at parameter setting mode, please refer to Section 4.1.5.
 4. For detailed operating flow at operating mode, please refer to Section 4.1.1.
 5. For detailed operating flow at **HELP** mode, please refer to Section 4.1.6.

4.1.3 Operation flow chart for the monitoring mode with operation panel

- PU mode as an example:

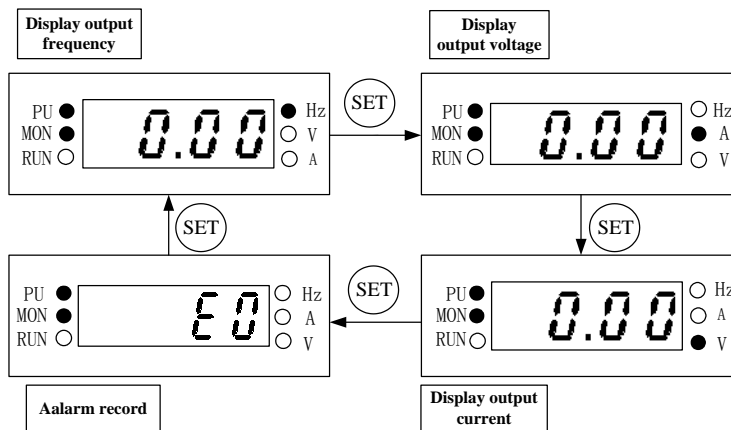

- Note: 1. At the monitoring output frequency mode, the indicating lamp of **MON** and **Hz** will be lit up, and at the same time the screen will display the current output frequency.
 2. At the monitoring output voltage mode, the indicating lamp of **MON** and **V** will be lit up, and the screen will display the current output voltage value.
 3. At the monitoring output current mode, the indicating lamp of **MON** and **A** will be lit up, and the screen will display the current output current value.
 4. At the browsing alarm record mode, the indicating lamp of **MON** will be lit up, and the screen will display the current alarm code.
 5. For the alarm codes, please refer to Appendix 2.

4.1.4 Operating flow chart for the frequency setting mode with operation panel

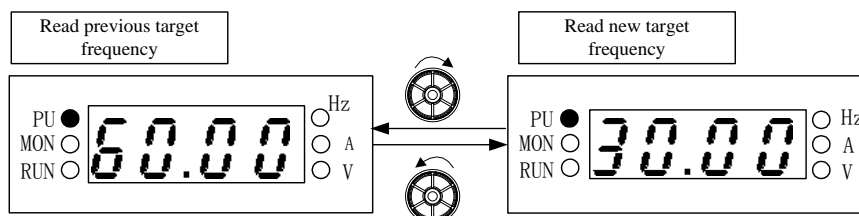

- Note: 1. When running the inverter, the frequency can be changed by the knob on the operation panel.
 2. At the frequency setting mode, the indicating lamp **Hz** will be lit up, but **MON** will be off.
 3. When setting up the frequency at the PU mode, the set value can not exceed the upper frequency. When high frequency is needed, change the upper frequency first.

4.1.5 Operating flow chart for the parameter setting mode with operation panel

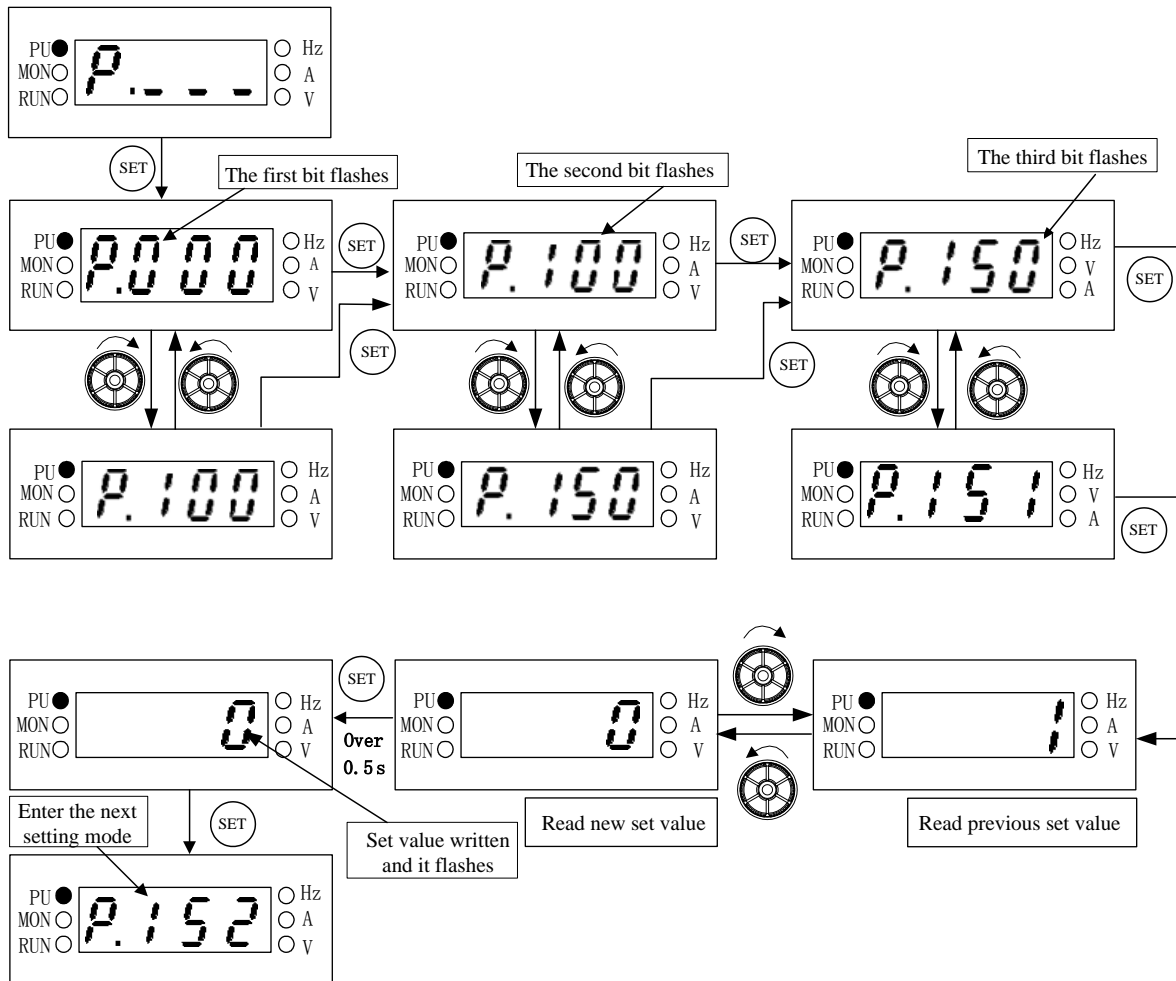

Note: At the parameter setting mode, both the indicating lamp of **Hz** and **MON** will be off. Please make sure to hold down the **SET** key for more than 0.5s when writing for the set value of the parameters.



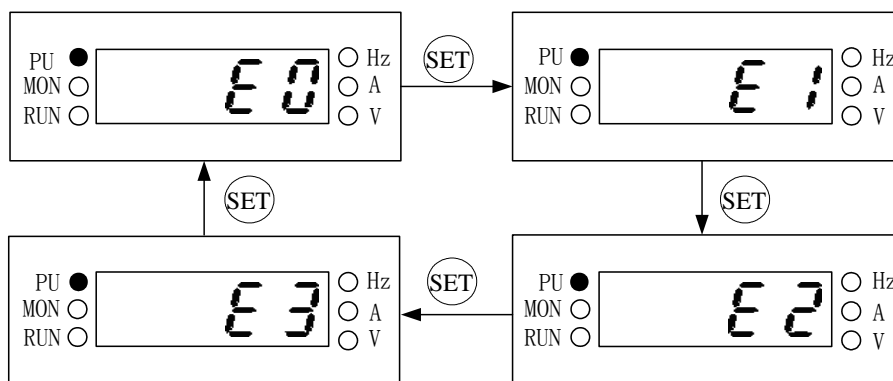



4.1.6 Operating flow chart for the HELP mode with operation panel







Note: 1. Browse different alarm record, the screen shows the recent 4 groups different alarm code.
2. For the alarm code, please refer to [Appendix 2](#).

4.2 Basic Operation Procedures for Different Modes



4.2.1 Basic operation procedures for the PU mode (P.79=0 or 1)

Steps	Description
1	<ul style="list-style-type: none"> Change the operation mode to PU mode, and the indicating lamp of PU  will be lit up. <p>Note: 1. When P.79=0, after the power is switched on or the inverter is reset, the inverter will enter the external mode first.</p> <p>2. For selecting and switching the operation modes, please refer to Section 4.1.</p>
2	<ul style="list-style-type: none"> Enter into the frequency setting mode, and write the target frequency into the memory. <p>Note: Please refer to Section 4.1.4 for the detailed setting procedures.</p>
3	<ul style="list-style-type: none"> Press  or  to run the motor. At this time, the indicating lamp of RUN  will flicker, indicating that the motor is running. The operation panel then enters into the monitoring mode automatically. (Please refer to P.110 in Chapter 5 for detailed descriptions.) <p>Note: 1. Please refer to Section 4.1.3 for the operating flow of the monitoring mode.</p> <p>2. The frequency setting mode is valid while the motor is running, and thus the target frequency can be changed to regulate the motor speed.</p>
4	<ul style="list-style-type: none"> Press  and the motor will start to decelerate until it stops. The indicating lamp of RUN  will stay on until the inverter stops outputting voltages.







4.2.2 Basic operation procedures for external mode (, P.79=0 or 2)

Steps	Description
1	<ul style="list-style-type: none"> The indicating lamp of EXT  will be lit up when changing the operation mode to the external mode. <p>Note: 1. When P.79=0, press  to switch to the operating mode after the power is turned on or the inverter is reset. The inverter will enter the external mode first, then press  or  to shift to PU mode.</p> <p>2. When P.79=2, the inverter will always be at the external mode.</p> <p>3. Please refer to Section 4.1 for selecting and switching the operation modes.</p>
2	<ul style="list-style-type: none"> Please refer to P.39 in Chapter 5 if the target frequency is set by the input signal across terminal 4-5. Please refer to P.4 in Chapter 5 if the target frequency is set by multi-speed stage levels. Please refer to P.38 in Chapter 5 if the target frequency is set by the input signal across terminal 2-5. Please refer to P.82 in Chapter 5 if the target frequency is given by the pulse. Please refer to multi-function terminals P.80~P.84, P.86 in Chapter 5 if programmable operating mode is chosen.

Primary Operation

Steps	Description
3	<ul style="list-style-type: none"> • Turn on STF or STR To run the motor. • At this time, the indicating lamp of RUN  will flicker, indicating that the motor is running. <p>Note: 1. Please refer to <u>P.78</u> and multi-function terminal <u>P.80~P.84, P.86</u> in Chapter 5 for advanced setting for starting terminals STF and STR.</p> <p>2. Please refer to <u>Section 4.1.3</u> for the operating procedure of the monitoring mode.</p> <p>3. Choose the programmed operation mode to have STF as the starting signal and STR as the pause signal. They will no longer act as the run forward or run reversely terminals.</p>
4	<ul style="list-style-type: none"> • Turn off STF or STR and the motor will decelerate till it stops. • The indicating lamp of RUN  will stay on until the inverter has stopped putting out voltages.



4.2.3 Basic operation procedure for the JOG mode ($\overset{\sim}{\underset{\sim}{U}}\overset{\sim}{\underset{\sim}{U}}$, P.79=0 or 1)

Steps	Description
1	<ul style="list-style-type: none"> • Change the operation mode to the JOG mode and the indicating lamp of PU  will be lit up. The screen will display $\overset{\sim}{\underset{\sim}{U}}\overset{\sim}{\underset{\sim}{U}}$ before the motor runs. <p>Note: Please refer to <u>Section 4.1</u> for selecting and changing the operation modes.</p>
2	<ul style="list-style-type: none"> • Press  or  to run the motor. The indicating lamp of RUN  will flicker, indicating that the motor is running. • Release  or  to decelerate the motor till it stops. The indicating lamp RUN  will stay on until the motor has stopped putting out voltages. <p>Note: 1. Please refer to <u>Section 4.1.3</u> for the operation procedures of the monitoring mode.</p> <p>2. The target frequency at the JOG mode is the value of <u>P.15</u>, and the acceleration/deceleration time is the value of P.16. Please refer to P.15 in Chapter 5.</p>







4.2.4 Basic operation procedure for the communication mode ($\overline{\overline{U}}$, P.79=3)

- In the communication mode, the user can set up parameters, run/stop, and reset the inverter by communication. Please refer to P.33 for details.

4.2.5 Basic operation procedure for combined mode 1 (H1, P.79=4)

Steps	Description
1	<ul style="list-style-type: none"> At the combined mode 1, the indicating lamp of PU  will flicker. <p>Note: Please refer to Section 4.1 for selecting and switching the operation modes,</p>
2	<ul style="list-style-type: none"> Enter into the frequency setting mode and write the target frequency into the memory. <p>Note: For operation procedures of the frequency setting mode, please refer to Section 4.1.4.</p>
3	<ul style="list-style-type: none"> Set up the target frequency by the operation panel and start the inverter by the external terminals. The indicating lamp of RUN  will flicker, indicating that the motor is running. <p>Note: For operating procedures of the monitoring mode, please refer to Section 4.1.3.</p>
4	<ul style="list-style-type: none"> Turn off STF or STR for the motor to decelerate till it stops. The indicating lamp of RUN  will stay on until the inverter has stopped putting out voltages.

4.2.6 Basic operation procedures for the combined mode 2 (H2, P.79=5)

Steps	Description
1	<ul style="list-style-type: none"> At the combined mode 2, the indicating lamp of PU  will flicker. <p>Note: For selecting and switching the operation mode, please refer to Section 4.1.</p>
2	<ul style="list-style-type: none"> The target frequency is set by external terminals. If the target frequency is set by the input signal across terminal 4-5, please refer to P.39 in Chapter 5. If the target frequency is set by multi-speed stage levels, please refer to P.4 in Chapter 5. If the target frequency is set by the input signal across terminal 2-5, please refer to P.38 in Chapter 5. If the target frequency is set by pulse, please refer to P.82 in Chapter 5.
3	<ul style="list-style-type: none"> Press  or  to run the motor. The indicating lamp of RUN  will flicker, indicating that the motor is running. <p>Note: 1. For operating procedures of the monitoring mode, please refer to Section 4.1.3. 2. The frequency setting mode is valid in case the motor is running, and thus the target frequency can be changed to regulate the motor speed.</p>
4	<ul style="list-style-type: none"> Press  to decelerate the motor till it stops. Indicating lamp of RUN  will stay on until the inverter has stopped putting out voltages.

4.2.7 Basic operation procedures for combined mode 3 (H3, P.79=6)

- Target frequency is determined by **communication**. When M0, M1, M2 and REX are 'On', the target frequency will be determined by the **combination of multi-speed stage levels** (Please refer to P.4~P.6, P.80~P.84, P.86). When **EXJ** is 'On', the target frequency will be determined by the set value of P.15. Acceleration/deceleration time is set by the value of P.16. The starting of the inverter is determined by **external terminals**. The functions of P.996, P.998 and P.999 can be accomplished by **communication**.

4.2.8 Basic operation procedure for combined mode 4 (H4, P.79=7)

- **Target frequency** of the inverter is determined by the **external terminals**, external voltage signals, external current signals, frequency set by pulse (P.82) or the combination of multi-speed stage level terminals. The starting of the inverter is determined by **communication** (including 'Reset').

4.2.9 Basic operation procedures for combined mode 5 (H5, P.79=8)

- Target frequency is determined by the **operation panel**. When M0, M1, M2 and REX are 'On', the target frequency is determined by the **combination of multi-speed stage levels** (Please refer to P.4~P.6, P.80~P.84, P.86). When **EXJ** is 'On', the target frequency will be determined by the set value of P.15. Acceleration/deceleration time is set by the value of P.16. The starting of the inverter is determined by **external terminals**.

4.3 Operation

4.3.1 Checking and preparation before operation

Examine the following aspects before the operation:

1. Check the wiring. Make sure that the AC motor driver output terminals (U/T1-V/T2-W/T3) are not connected to the power and the grounding terminals are well grounded.
2. Check whether the terminals or the exposure of charged has short circuit.
3. Make sure the terminal connections, plug connectors (optional) and screws are well fastening.
4. Make sure the motor is not connected to the mechanical device.
5. All switches must be disconnected before turning on the power. Make sure not to start the inverter and if there is any abnormal action.
6. Turn on the power only after cover installation.
7. Do not touch the operation switch with wet hands.
8. Make sure that the following aspects are followed when power on:
 Operation panel should be shown no fault. The indicating lamp of **Hz** and **MON** are all lit up when the keyboard panel is not chosen.

4.3.2 Operating methods

For various operating methods, please refer to Chapter 4 for basic operating procedures and chapter 5 for parameter descriptions. Selecting the most appropriate operation method according to applicable requirements and regulations. Commonly used operating methods are shown below:

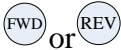
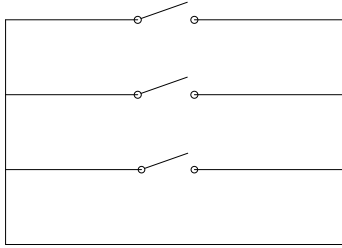



Operating Methods	Reference Source of Target Frequency	Signal Source of Motor Starting
Operation Panel	the knob on the operation panel	
External Terminals Signal Operation	 <div style="display: inline-block; vertical-align: middle; margin-left: 10px;"> M0 M1 M2 SD </div> <div style="display: inline-block; vertical-align: middle; margin-left: 10px;"> Parameter setting: P.4=40 P.5=30 P.6=10 </div>	Input by external terminals: STF-SD STR-SD
	2-5,4-5	

4.3.3 Trial Run

Check the cables and make sure that there are no abnormalities before the operation. The inverter will be at the external mode after turning on the power.

1. After turning on the power, make sure that Operation panel shown no fault, the indicating lamp of **Hz** and **MON** are all lit up when the keyboard panel is not chosen.
2. Pick up a switch between STF and SD or STR and SD.
3. Pick up a potentiometer among 2-5-10 or provide 0~5V DC between 2 and 5.
4. Adjust the potentiometer to a minimum value between or 0 and 5V DC (under 1V).
5. There is a forward rotation if STF is on, or a reverse rotation if STR on. Turn off STF or STR for the motor to decelerate till it stops.
6. Make sure of the following aspects:
 - 1) Motor rotation direction is correct.
 - 2) A smooth motor rotation (no abnormal noise or vibration).
 - 3) A smooth acceleration and deceleration.

Set up the DU06 operation panel as follows:

1. Properly connect the DU06 operation panel to the inverter.
2. Change the operation mode to the PU mode after turning on the power, and the screen will display 50/60Hz.
3. Press  to set the target frequency to 5Hz.
4. Press  for forward rotation; press  for reverse rotation; press  for motor decelerate till it stops.
5. Examining the following aspects:
 - 1) A correct motor rotation direction.
 - 2) A smooth motor rotation (no abnormal noise or vibration).
 - 3) A smooth acceleration and deceleration.

If there is no abnormal condition, increase the frequency to test the motor in a continuous running state. Start the operation if no abnormal condition is found from the above commissioning.

Note: If the inverter or the motor runs anomalous, stop the operation immediately. Check the causes according to the Fault Diagnosis. Though the inverter is stopped, power terminal (R/L1-S/L2-T/L3) of the main circuit is still connected. In this case electric shock may occur when touching the output terminals (U/T1-V/T2-W/T3) of the inverter. Because the filter capacitor has recharging voltage and a complete discharging takes some times, electric shock may happen even if the major loop power has been shut off. So after shutting off the major loop power, use a DC voltage meter to test the intermediate DC loop. Confirm the safe voltage value before handling the circuit inside inverter.

5. Parameter Description

(1) Adjusting the output torque of motor (current)

5.1 Torque Boost (P.0, P.46) <input type="checkbox"/> V/F	47
5.11 Stall Prevention (P.22, P.23, P.66)	58
5.40 Slip Compensation Coefficient (P.89) <input type="checkbox"/> V/F	111
5.47 Zero-speed Function (P.151~P.152) <input type="checkbox"/> V/F	117
5.48 Over Torque Detection (P.155~P.156, P.260)	118
5.68 Voltage Stall Level (P.268)	140
5.74 Motor Control Mode (P.300 and P.301)	143
5.75 Motor Parameter (P.302~P.309)	145
5.76 Sliding Compensation Gain (P.320)	146
5.77 Torque Compensation Filter (P.321)	146

(2) Output frequency limit

5.2 Range of the Output Frequency (P.1, P.2, P.18)	48
5.42 Frequency Jump (P.91~P.96)	112

(3) V/F curve setting

5.3 Base Frequency and Base Frequency Voltage (P.3, P.19, P.47)	49
5.9 Load Pattern Selection (P.14, P.98, P.99, P.162~P.169)	55

(4) Setting frequency by external terminal

5.4 Multi-speed (P.4~P.6, P.24~P.27, P.142~P.149)	50
5.10 JOG Mode (P.15, P.16)	58
5.28 Remote Control Function Selection (P.61,P.219)	96

(5) The setting of acceleration and deceleration time or mode

5.5 Acceleration/Deceleration Time (P.7, P.8, P.20, P.21, P.44, P.45)	51
5.8 Starting Frequency (P.13)	54
5.13 Acceleration/deceleration Curve Selection (P.29, P.255~P.258)	60
5.44 Programmed Operation Mode (P.100~P.108, P.111~P.118, P.121~P.123, P.131~P.138)	113
5.46 The selection of positive and reverse rotation dead time (P.119)	116

(6) The selection and protection of motor

5.6 Electronic Thermal Relay Capacity (P.9)	53
---	----

(7) Braking and stopping of the motor

5.7 DC Injection Brake (P.10, P.11, P.12)	53
5.14 Regenerative Brake (P.30, P.70)	63
5.31 Brake Selection (P.71)	101
5.64 DC Injection Brake Function before Starting (P.242~P.244) <input type="checkbox"/> V/F	135

(8) Distribution and control of the external terminal's function

5.21 Multi-function Output (P.40, P.64, P.74, P.85, P.120 and P.187)	88
5.22 Up-to-frequency Sensitivity (P.41)	91
5.23 Output Frequency Detection (P.42, P.43)	92

<u>5.24 AM Terminal (P.54~P.56, P.190, P.191)</u>	93
<u>5.29 Zero Current Detection (P.62, P.63)</u>	99
<u>5.37 Multi-function Terminals Function Selection (P.80~P.84, P.86)</u>	105
<u>5.38 Multi-Function Control-Terminal Input Positive/Negative Logic (P.87)</u>	110
<u>5.39 Multi-Function Output Terminal Positive/Negative Logic(P.88)</u>	110
<u>5.49 External Terminals Filter Adjusting Function (P.157)</u>	119
<u>5.67 Maintenance Alarm Function (P.261)</u>	140

(9) The monitor display and output signal

<u>5.12 Output Frequency Filter Constant (P.28)</u>	59
<u>5.18 Speed Display (P.37, P.259)</u>	82
<u>5.45 Operation Panel Monitoring Selection (P.110)</u>	115
<u>5.52 Multi-function Display (P.161)</u>	120

(10) The motion selection when the power cuts out in the moment

<u>5.25 Restart Function (P.57, P.58, P.150) <input type="checkbox"/> V/F</u>	94
---	----

(11) The motion setting when something unusual happened

<u>5.30 Retry (P.65, P.67, P.68, P.69)</u>	100
<u>5.54 4-5 Terminal Disconnection Handling (P.184)</u>	126
<u>5.69 Vibration Inhibition Factor (P.286)</u>	140
<u>5.70 Short Circuit Protection Function (P.287)</u>	141

(12) Running with energy saving

<u>5.51 Energy-saving Control Function (P.159) <input type="checkbox"/> V/F</u>	119
---	-----

(13) The noise reducing of motor and electromagnetism

<u>5.15 Soft-PWM Selection (P.31)</u>	63
<u>5.32 Carrier Frequency (P.72)</u>	102

(14) The setting of analog input frequency and torque (terminal 2 and 4)

<u>5.19 Voltage Signal Selection and Target Frequency (P.38, P.73, P.139~P.141)</u>	83
<u>5.20 The Input Signal across Terminal 4-5 and the Target Frequency (P.17, P.39)</u>	87
<u>5.27 Input Signal Filter Constant (P.60)</u>	96
<u>5.43 The Second Frequency Source (P.97)</u>	112
<u>5.55 Proportion Linkage Function (P.185)</u>	127
<u>5.58 Input Signal across Terminal 2-5 (P.192~P.195)</u>	129
<u>5.59 Input Signal across Terminal 4-5 (P.196~P.199)</u>	130
<u>5.63 Auxiliary Frequency Function (P.240)</u>	135

(15) Misoperation prevention and frequency setting limit

<u>5.26 The Choice of Locking Operation Keyboard Knob Setting (P.59)</u>	95
<u>5.33 Stop or Reset Function Selection (P.75)</u>	103
<u>5.34 Parameters Write Protection (P.77)</u>	103
<u>5.35 Forward/Reverse Rotation Prevention Selection (P.78)</u>	104
<u>5.57 Factory Setting Function (P.189)</u>	128
<u>5.73 Password Protection Function (P.294 and P.295)</u>	142

(16) The selection of the running mode and the operation site

5.17 Communication Running and Speed Command (P.35)	82
5.36 Operation Mode Selection (P.79).....	104
5.50 External Terminal Power Enable Function (P.158).....	119

(17) The communicational running and setting

5.16 Communication Function (P.32, P.33, P.36, P.48~P.53, P.153~P.154)	64
--	----

(18) Specific running and frequency control

5.53 PID Control (P.170~P.183, P.223~P.225,P.251)	121
5.60 The Paver Function (P.226~P.228)	131
5.61 Backlash Compensation and Acceleration/Deceleration Interrupted for Waiting Function (P.229~P.233) V/F.....	132
5.62 Triangular Wave Function (P.234~P.239) V/F	134
5.66 Commercial Power Supply Frequency Operation Function (P.247~P.250) V/F.....	137

(19) Convenient function

5.41 The Inverter Model (P.90).....	111
5.56 Firmware version (P.188).....	127
5.65 Options for Stopping the Cooling Fan (P.245)	136
5.71 Alarm History Parameters (P.288~P.291)	141
5.72 Accumulative Motor Operation Time Function (P.292, P.293)	142
5.78 Parameter Copy Function (Pr.CP and Pr.CA) (DU06 operation panel needs to be purchased).....	146

(20) Clearing away the abnormal alarm record

5.79 Alarm History Clear (P.996)	147
--	-----

(21) Resetting the inverter

5.80 Inverter Reset (P.997)	147
-----------------------------------	-----

(22) Restoring the parameter to a default value

5.81 Restoration of the Parameters to the Default Values (P.998 and P.999).....	148
---	-----

5.1 Torque Boost (P.0, P.46) V/F

P.0 “Torque boost”

P.46 “The second torque boost”

— Related parameters —

P.3 “Base frequency”
 P.19 “Base frequency voltage”
 P.47 “The second base frequency”
 P.80~P.84, P.86
 “Multi-function terminals selection”

- For an inverter controlled by the V/F mode, the starting torque is usually inadequate when starting the motor because the output voltage of the inverter is inadequate. In this case, improve the output voltage by setting up a proper torque boost (P.0) to obtain a better starting torque.

Parameter	Factory Setting	Setting Range	Remarks
0	6% (0.4Kw~0.75Kw)	0~30%	---
	4% (1.5Kw~3.7Kw)		
	3% (5.5Kw)		
46	9999	0~30%, 9999	9999: function invalid

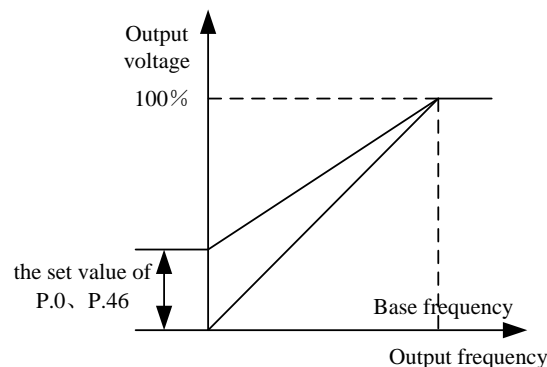

<Setting>

- If P.0=6% and P.19=220V, and output frequency of the inverter is 0.2Hz, the output voltage will be:

$$P.19 \times \left(\frac{0.2\text{Hz}}{50\text{Hz}} + P.0 \right) = 220\text{V} \times (0.004 + 6\%) = 14.08\text{V}$$

- If RT is ‘ON’, P.46 The Second Torque Boost will be valid.

Note: 1. A too large set value of P.0 may cause actions of the current protection of the inverter or the inverter will be disabled for a smooth start.
 2. The second function is valid only when P.44 is not equal to 9999.
 3. RT in this paragraph is referred to as the multi-function control terminals. For selecting the function and using the multi-function control terminal, please refer to P.80~P.84, P.86. For the wiring, please refer to Section 3.5.6.

5.2 Range of the Output Frequency (P.1, P.2, P.18)

P.1 “Maximum frequency”

P.2 “Minimum frequency”

P.18 “High-speed maximum frequency”

Related parameters

P.13 “Starting frequency”

- The upper limit and the lower limit of the output frequency can be restricted.

Parameter	Factory Setting	Setting Range	Remarks
1	120Hz	0~120Hz	---
2	0Hz	0~120Hz	---
18	120Hz	120~650Hz	---

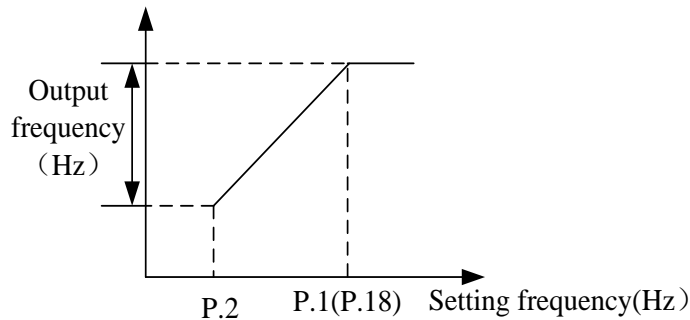

<Setting>

- If the target frequency \cong P.2, the steady output frequency = P.2.
- If $P.2 < \text{target frequency} \cong P.1$ (P.18), the steady output frequency = the target frequency.
- If $P.1$ (P.18) $<$ target frequency, the steady output frequency = P.1.

Note: 1. The maximum frequency and the high-speed maximum frequency are interrelated. P.1 must be used (the setting range of P.1 is 0~120Hz) if the target upper limit frequency is in the range of 0~120Hz. P.18 must be used (the setting range of P.18 is 120~650Hz) if the target upper limit frequency is in the range of 120~650Hz.

2. If $P.1 < P.2$, the steady output frequency will be clamped to P.1.
3. The set frequency value can not exceed the value of P.1.

5.3 Base Frequency and Base Frequency Voltage (P.3, P.19, P.47)

P.3 “Base frequency”

P.19 “Base frequency voltage”

P.47 “The second base frequency”

Related parameters

P.14 “Load pattern selection”
 P.80~P.84, P.86
 “Multi-function terminals selection”
 P.189 “Factory setting function”

- The maximum output voltage of the inverter is referred to as “Base frequency voltage”.
- If the output frequency is lower than the base frequency, the output voltage of the inverter will increase with the output frequency. If the output frequency has reached the base frequency (P.3/P.47), the output voltage will be equal to the base frequency voltage. If the output frequency exceeds the base frequency and increase continuously, the output voltage will be clamped to the base frequency voltage.

Parameter	Factory Setting	Setting Range	Remarks
3	50Hz	0~650Hz	When P.189=1
	60Hz		When P.189=0
19	9999	0~1000V, 9999	9999: Change according to the power source voltage.
47	9999	0~650Hz	9999: function invalid

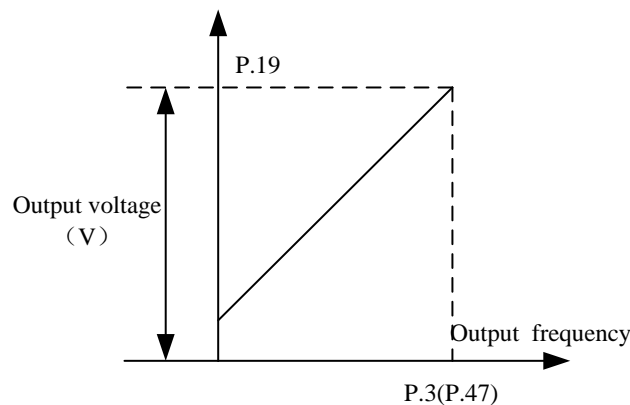

<Setting>

- The base frequency is set through P.3 and P.47.
- If RT is on, P.47 The Second Base Frequency is valid (Note 1).
- The base frequency voltage is set through P.19 (Note 2).

Note: 1. The second function is valid only when P.44≠9999.
 2. If P.19=9999, the maximum output voltage of the inverter will depend on the value of the power supply voltage.
 3. RT in this paragraph is referred to as the multi-function control terminals. For selecting the function and use of the multi-function control terminal, please refer to P.80~P.84, P.86. For the wiring, please refer to Section 3.5.6.

5.4 Multi-speed (P.4~P.6, P.24~P.27, P.142~P.149)

P.4 “Speed 1(high speed)”

P.5 “Speed 2(medium speed)”

P.6 “Speed 3 (low speed)”

P.24~P.27 “Speed 4 to 7”

P.142~P.149 “Speed 8 to 15”

— Related parameters —

- P.1 “Maximum frequency”
- P.2 “Minimum frequency”
- P.29 “Acceleration /deceleration curve selection”
- P.79 “Operation mode selection”
- P.80~P.84, P.86
“Multi-function terminals selection”

Parameter	Factory Setting	Setting Range	Remarks
4	60Hz	0~650Hz	---
5	30Hz	0~650Hz	---
6	10Hz	0~650Hz	---
24~27	9999	0~650Hz, 9999	9999, is not chosen
142	0Hz	0~650Hz	---
143~149	9999	0~650Hz, 9999	9999, is not chosen

<Setting>

- If all the setting values of P.24~P.27 and P.142~P.149 are not equal to 9999, the 16-speed operation will be activated. It means that there are a total of 16 kinds of speeds from the combination of RL, RM, RH and REX. For the setting of the target frequency of the inverter, please refer to the figure below.

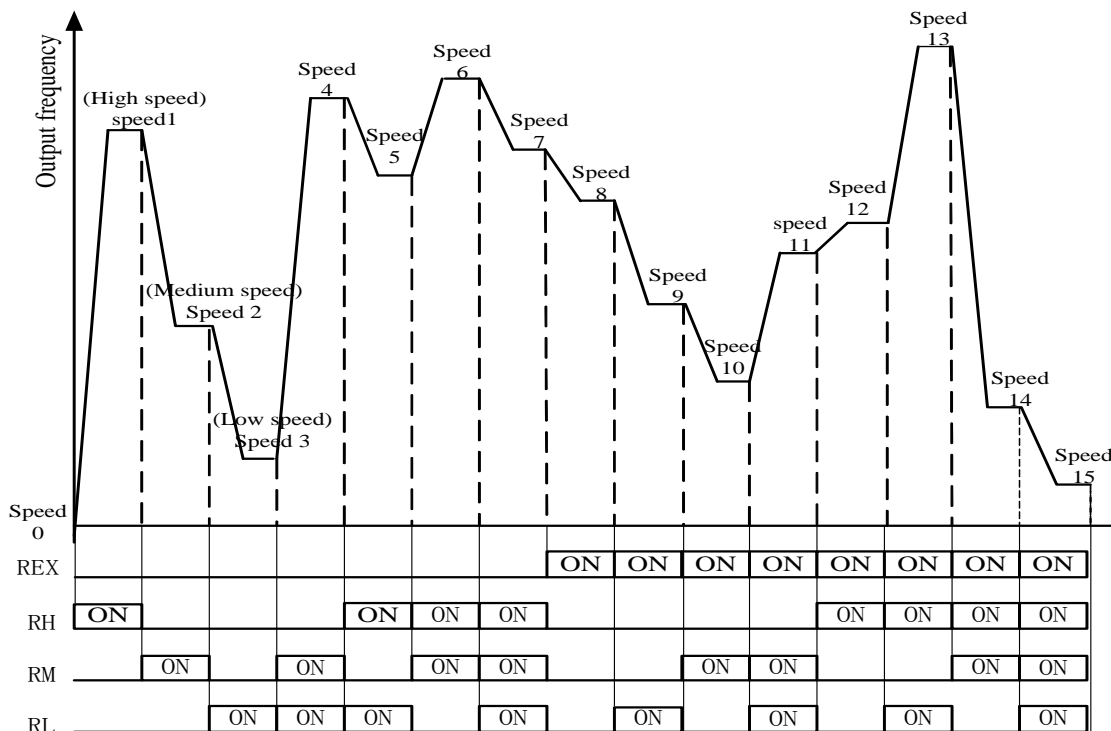

Parameter Description

• Provided that the values of P.24~P.27 and P.142~P.149 are all defaulted, the ‘3-speed operation’ is active. In this case, the target frequency can be set as follows (the priority for the terminals is RL>RM>RH):

Parameter Target Frequency	P.24= 9999	P.25= 9999	P.26= 9999	P.27= 9999	P.142= 9999	P.143= 9999	P.144= 9999	P.145= 9999	P.146= 9999	P.147= 9999	P.148= 9999	P.149= 9999
RL (P.6)	○	○		○	○	○		○		○		○
RM (P.5)			○				○				○	
RH (P.4)									○			

For example: if P.26=9999, the target frequency is determined by RM (the setting value of P.5).

Note: 1. The multi-speed is valid only at the external mode, the combined mode 2, the combined mode 4 or the combined mode 5.
 2. RL, RM, RH and REX mentioned in this section are the function names of the multi-function control terminal. (For example: P.80=2, M0 terminal is chosen to perform the RL function). Please refer to P.80~P.84, P.86 for multi-function selection, and refer to Section 3.5.6 for wiring.

5.5 Acceleration/Deceleration Time (P.7, P.8, P.20, P.21, P.44, P.45)

P.7 “Acceleration time”

P.8 “Deceleration time”

P.20 “Acceleration/deceleration reference frequency”

P.21 “Acceleration/deceleration time increments”

P.44 “The second acceleration time”

P.45 “The second deceleration time”

— Related parameters —

- P. 3 “Base frequency”
- P. 29 “Acceleration/deceleration curve selection”
- P. 47 “The second base frequency”
- P.80~P.84, P.86
“Multi-function terminal selection”
- P. 189 “Factory setting function”

- When the output frequency of the inverter accelerates from 0 Hz to P.20, the required time is defined as acceleration time (P.7).
- When the output frequency of the inverter decelerates from P.20 to 0 Hz, the required time is defined as deceleration time (P.8).
- P.21 is used to set the acceleration/deceleration time and minimum setting increments.

Parameter Description

Parameter	Factory Setting	Setting Range	Remarks
7	5s (3.7KW and below)	0~360s	When P.21=0
	10s (5.5KW)	0~3600s	When P.21=1
8	5s (3.7KW and below)	0~360s	When P.21=0
	10s (5.5KW)	0~3600s	When P.21=1
20	50Hz	1~650Hz	When P.189=1
	60Hz		When P.189=0
21	0	0, 1	0 Minimum setting increment:0.01s
			1 Minimum setting increment:0.1s
44	9999	0~360s	When P.21=0
		0~3600s	When P.21=1
		9999	Not chosen
45	9999	0~360s	When P.21=0
		0~3600s	When P.21=1
		9999	Not chosen

<Setting>

- If P.21=0, the minimum increment of acceleration/deceleration time (P.7, P.8, P.16, P.44, P.45, and P.111~P.118) is 0.01 seconds.
- If P.21=1, the minimum increment of acceleration/deceleration time (P.7, P.8, P.16, P.44, P.45, and P.111~P.118) is 0.1 seconds.
- If RT is on, the second function is valid. In this case, the running characteristics of the motor are refer to as the second function.
- If P.44=9999 (the default value), all of the second function is disabled. In this case, even though RT is on, the acceleration time is still the set value of P.7, and the deceleration time is still the set value of P.8, the torque boost is still the set value of P.0, and the base frequency is still the set value of P.3.
- If P.44≠9999 and P.45=9999, the acceleration/deceleration time is the set value of P.44 when RT is on.
- If P.44≠9999 and P.46=9999, the torque boost is the set value of P.0 when RT is on.
If P.44≠9999 and P.46≠9999, the torque boost is the set value of P.46 when RT is on.
- If P.44≠9999 and P.47=9999, the base frequency is the set value of P.3 when RT is on.
If P.44≠9999 and P.47≠9999, the base frequency is the set value of P.47 when RT is on.

Note: RT in this paragraph is referred to as the multi-function control terminals. Please refer to P.80~P.84, P.86 for function selection and features and refer to Section 3.5 for wiring.

5.6 Electronic Thermal Relay Capacity (P.9)

P.9 “Electronic thermal relay capacity”

—Related parameters—
P.80~P.84, P.86
“Multi-function terminals selection”

- To simulate a thermal relay to prevent the motor from overheating, the electronic thermal relay employs a built-in program.

Parameter	Factory Setting	Setting Range	Remarks
9	0A	0~500A	---

<Setting>

- Please set P.9 as the rated current of the motor at its rated frequency. The rated frequency of a squirrel-cage inductive motor made by different countries and areas will be different. Please refer to the nameplate instruction of the motor.
- If P.9=0, the electronic thermal relay is disabled.
- In case the calculated heat by the electronic thermal relay exceeds the upper limit, the alarm will be activated (lit up), the screen of the operation panel will display $\overline{H\overline{H}}$, and the output will be stopped.

Note: 1. After resetting the inverter, the thermal accumulating record of the electronic thermal relay will be reset to zero. Attention should be paid.
 2. When two or more motors are connected to the inverter, they cannot be protected by the electronic thermal relay. Install an external thermal relay to each of the motors.
 3. When a special motor is employed, the electronic thermal relay is no longer valid. Install an external thermal relay to each of the motors.
 4. For information related to the wiring for an external thermal relay, refer to P.80~P.84, P.86.

5.7 DC Injection Brake (P.10, P.11, P.12)

P.10 “DC injection brake operation frequency”

P.11 “DC injection brake operation time”

P.12 “DC injection brake operation voltage”

Parameter	Factory Setting	Setting Range	Remarks
10	3Hz	0~120Hz	---
11	0.5s	0~60s	---
12	4%	0~30%	---

<Setting>

- The stop signal (please refer to [Chapter 4](#) for the primary operation) will cause a gradual decrease of the output frequency of the inverter. In case the output frequency reaches the DC injection brake operation frequency (P.10), the DC injection brake will be activated.
- During DC injection brake, a DC voltage will be injected into the motor windings by the inverter, which is used to lock the motor rotor. This voltage is called DC injection brake operation voltage (P.12). The larger the P.12 value is, the higher the DC braking voltage and the stronger the braking capability.
- The DC brake operation will last for a period (the set value of P.11) to overcome motor inertia. To achieve an optimum control, P.11 and P.12 should be set properly.

As shown below:

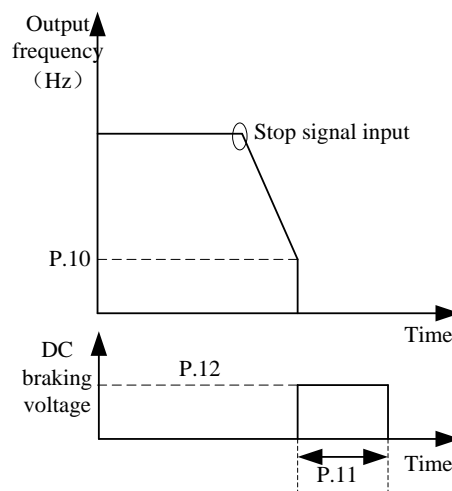

Note: Users must set P.11 and P.12 appropriately in order to obtain the best control characteristics.

5.8 Starting Frequency (P.13)

P.13 “Starting frequency”

—Related parameters—

P.2 “Minimum frequency”

- When starting the motor, the instant output frequency of the inverter refer to as the starting frequency.

Parameter	Factory Setting	Setting Range	Remarks
13	0.5Hz	0~60Hz	---

<Setting>

- The motor will not run if the target frequency of the inverter is lower than the setting value of P.13. Inputting the motor starting signal will cause an increase of the output frequency from the value of P.13.

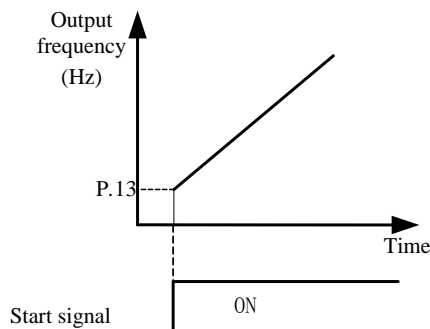

5.9 Load Pattern Selection (P.14, P.98, P.99, P.162~P.169)

P.14 “Load pattern selection”

P.98 “Middle frequency 1”

P.99 “Output voltage 1 of middle frequency”

P.162 “Middle frequency 2”

P.163 “Output voltage 2 of middle frequency”

P.164 “Middle frequency 3”

P.165 “Output voltage 3 of middle frequency”

P.166 “Middle frequency 4”

P.167 “Output voltage 4 of middle frequency”

P.168 “Middle frequency 5”

P.169 “Output voltage 5 of middle frequency”

—Related parameters—

- P. 0 “Torque boost”
- P. 46 “The second torque boost”
- P. 80~P. 84 ,P. 86
- “Multi-function terminals selection”

Parameter	Factory Setting	Setting Range	Remarks
14	0	0~13	There are nine kinds of VF curve when P.14=4~13.
98	3Hz	0~650Hz	---
99	10%	0~100%	---
162	9999	0~650Hz, 9999	---
163	0%	0~100%	---
164	9999	0~650Hz, 9999	---
165	0%	0~100%	---
166	9999	0~650Hz, 9999	---
167	0%	0~100%	---
168	9999	0~650Hz, 9999	---
169	0%	0~100%	---

<Setting>

- If P.14=4, P.19=220V, P.98=5Hz and P.99=10%, the output voltage equals to $P.99 \times P.19 = 10\% \times 220V = 22V$ when the inverter is run at 5Hz.
- P.46 The Second Torque Boost is valid if RT is on.

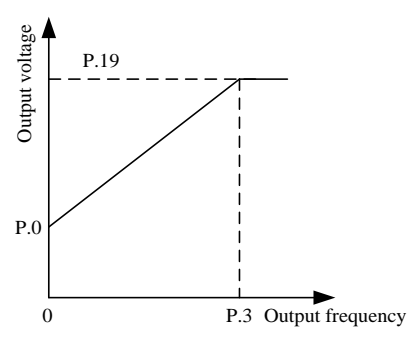
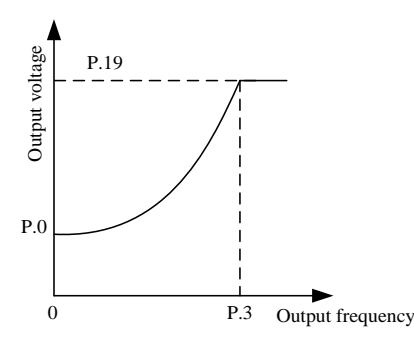
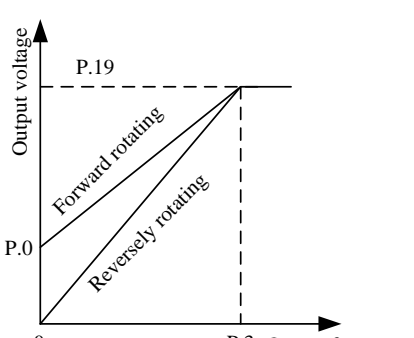
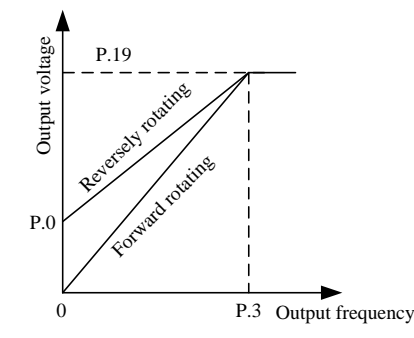
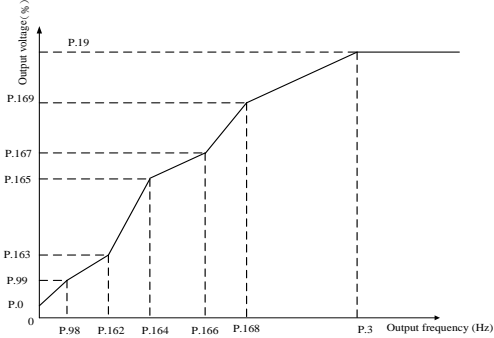
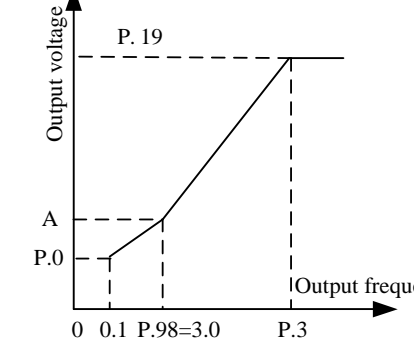
<p style="text-align: center;">P.14=0</p>  <p style="text-align: center;">Applicable to constant torque loads (conveyor belt, etc.)</p>	<p style="text-align: center;">P.14=1</p>  <p style="text-align: center;">Applicable to variable torque loads (fans, pumps, etc.)</p> <p style="text-align: center;">Curve equation of output voltage and output frequency is:</p> $V = \frac{(\text{Base voltage} - \text{Base voltage} * P.0) * \text{Output frequency}^2}{\text{Base frequency}^2} + \text{Base voltage} * P.0$
<p style="text-align: center;">P.14=2</p>  <p style="text-align: center;">Ascending/descending loads</p>	<p style="text-align: center;">P.14=3</p>  <p style="text-align: center;">Ascending/descending loads</p>
<p style="text-align: center;">P.14=4</p>  <p>A high startup torque or descending torque is due to the set values (Note 1).</p>	<p style="text-align: center;">P.14=5</p>  <p>A is 7.1% when P.14=5.</p>

<p style="text-align: center;">P.14=6, 7, 8</p> <p>When P.14=6, A is 8.7%; when P.14=7, A is 10.4%; when P.14=8, A is 12.0%.</p>	<p style="text-align: center;">P.14=9, 10</p> <p>When P.14=9, A is 20.0%; when P.14=10, A is 25.0%.</p>
<p style="text-align: center;">P.14=11, 12, 13</p> <p>When P.14=11, A is 9.3%; when P.14=12, A is 12.7%; when P.14=13, A is 16.1%.</p>	

Note: 1. According to the diagram above, set up the values of P.98, P.99 if one point is required; set up values of P.98, P.99, P.162, P.163 if two points are required; set up the values of P.98, P.99, P.162, P.163, P.164, P.165 if three points are required; and so forth.

2. If P.14 is set between 4 and 13, the curve will be invalid when the value of P.0 is larger than the value of A and the value of P.14 will be equal to P.0

5.10 JOG Mode (P.15, P.16)

P.15 “JOG frequency”

P.16 “JOG acceleration/deceleration time”

Related parameters

- P.20 “Acceleration/deceleration reference frequency”
- P.21 “Acceleration/deceleration time increments”

- At the JOG mode, the output frequency is the set value of P.15, and the acceleration/deceleration time is the set value of P.16.

Parameter	Factory Setting	Setting Range	Remarks
15	5Hz	0~650Hz	---
16	5s	0~360s	When P.21=0
		0~3600s	When P.21=1

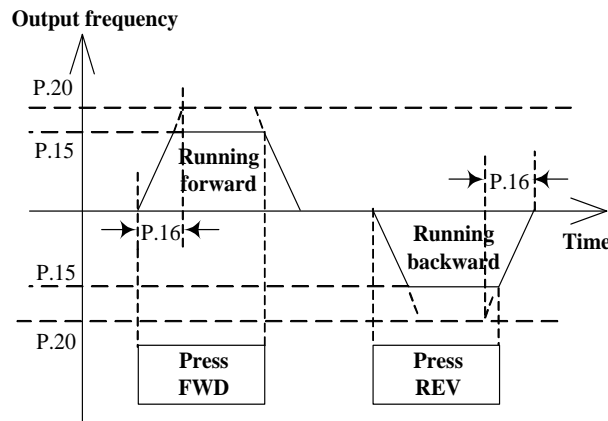

Note: Please refer to Section 4.1 for entering into the JOG mode.

5.11 Stall Prevention (P.22, P.23, P.66)

P.22 “Stall prevention operation level”

P.23 “Compensation factor at level reduction”

P.66 “Stall prevention operation reduction starting frequency”

Related parameters

- P.189 “Factory setting function”

- Motor speed often fail to closely follow the output frequency when starting the motor or increasing the target frequency under heavy load. Increase the output current to improve the output torque if the motor speed is smaller than the output frequency. However, the motor torque will decrease if the difference between the output frequency and the motor speed is too large, which is referred to as stall.

Parameter	Factory Setting	Setting Range	Remarks
22	200%	0~250%	---
23	9999	0~200%, 9999	When P.23=9999, stall prevention operation level is the set value of P.22.
66	50Hz	0~650Hz	When P.189=1
	60Hz		When P.189=0

<Setting>

- During the period of starting a motor or increasing the output frequency, the output current of the inverter will increase. Once the output current exceeds the pre-set upper limit (as in the following figure), adjustment of the output frequency will be paused automatically and will not proceed until the motor has reached the output frequency (at this moment, the output current of the inverter will decrease correspondingly).

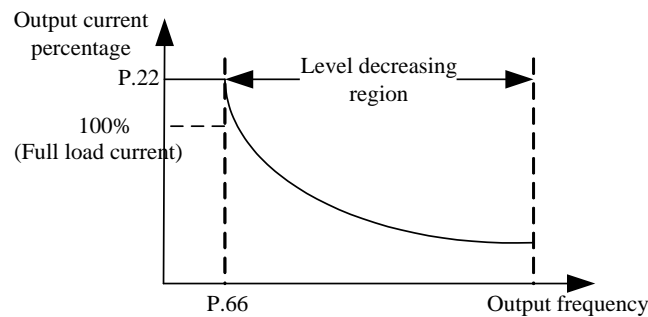

$$\text{Level percentage} = A + B \times \frac{P.22 - A}{P.22 - B} \times \frac{P.23 - 100}{100}$$

$$A = \frac{P.66 \times P.22A}{\text{Output frequency}} \quad B = \frac{P.66 \times P.22A}{400}$$

5.12 Output Frequency Filter Constant (P.28)

P.28 “Output frequency filter constant”

- Decreasing the acceleration/deceleration time or altering the output frequency from high-frequency to low-frequency or vice versa can cause machine vibration and thereby affecting the product quality.
- To reduce the machine vibration, the output frequency can be filtered when altering from high-frequency to low-frequency or vice versa by setting the output frequency filter constant P.28. The bigger the set value of P.28, the better the filter effect, but the corresponding response delay will increase. The filter function is invalid if the set value of P.28 is 0.

Parameter	Factory Setting	Setting Range	Remarks
28	0	0~31	---

5.13 Acceleration/deceleration Curve Selection (P.29, P.255~P.258)

P.29 “Acceleration/deceleration curve selection”

P.258 “S pattern time at the end of Deceleration”

P.255 “S pattern time at the beginning of Acceleration”

P.256 “S pattern time at the end of Acceleration”

P.257 “S pattern time at the beginning of Deceleration”

— Related parameters —

- P. 3 “ Base frequency ”
- P. 7 “ Acceleration time ”
- P. 8 “ Deceleration time ”
- P. 20 “Acceleration / deceleration reference frequency”
- P. 44 “The second acceleration time”
- P. 45 “The second deceleration time”

Parameter	Factory Setting	Setting Range	Remarks
29	0	0~3	---
255	0.2s	0~25s	They are valid in the mode of S pattern acceleration/deceleration mode (P.29=3) and used to set the acceleration time of S pattern acceleration/deceleration. If 9999 is set, the time corresponds to the value of P.255.
256	9999	0~25s,9999	
257	9999	0~25s,9999	
258	9999	0~25s,9999	

<Setting>

• **The Linear acceleration/deceleration curve when P.29=0:**

The acceleration slope is constructed by combining P.7 and P.20. The deceleration slope is constructed by combining P.8 and P.20.

The target frequency increases and decreases linearly as the acceleration and the deceleration slopes presented in the figure below.

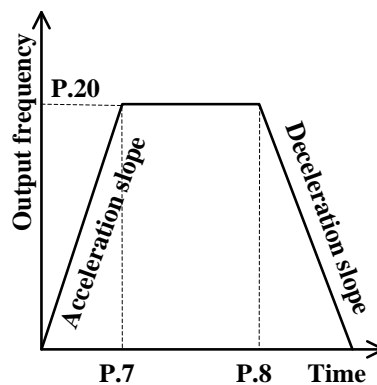

• **S-shape acceleration/deceleration curve 1 when P.29=1:**

The acceleration slope is formed by combining P.7 and P.3. The deceleration slope is formed by combining P.8 and P.3.

The acceleration and deceleration curves are in an S-shape.

The equation for the ascending S-shape curve between 0 and P.3 is:

$$f = \left[1 - \cos \left(\frac{90^\circ \times t}{P.7} \right) \right] \times P.3$$

The equation for the ascending S-shape curve above P.3 is:

$$t = \frac{4}{9} \times \frac{P.7}{P.3^2} \times f^2 + \frac{5}{9} \times P.7$$

t: Time f: Output frequency

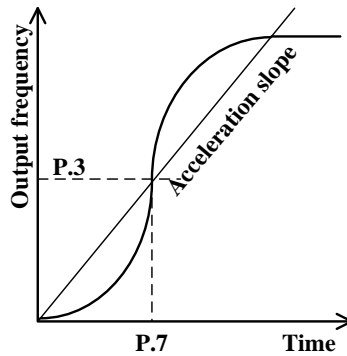

Note: This pattern is applicable to the mainframes of working machines.

• **The S-shape acceleration/deceleration curve 2 when P.29=2**

An acceleration slope is formed by combining P.7 and P.20. A deceleration slope is formed by combining P.8 and P.20.

The target frequency increases and decreases as the acceleration and deceleration slopes presented in the figure below. As shown in the figure below, adjusting the setting value of the inverter from f0 to f2 will result in S-shape acceleration with a time equal to $P.7 \times (f2-f0)/P.20$. On the other hand, adjusting the setting value of the inverter from f2 to f3 will result in S-shape acceleration with a time equal to $P.7 \times (f3-f2)/P.20$. See the figure below.

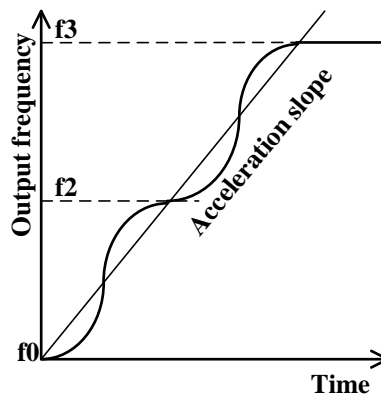

Note: This s-shape curve enables a substantial motor vibration reduction during the acceleration/deceleration, and thus extends the life span of the belts and the gears.

• When P.29=3, “S pattern acceleration /deceleration curve 3”

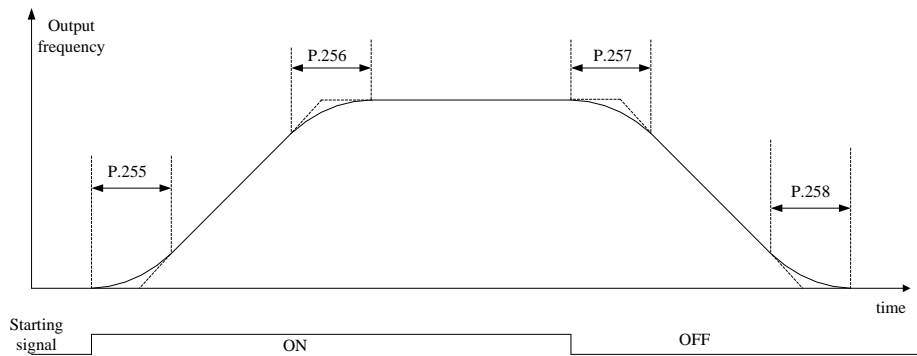

- 1) The parameters P.255, P.256, P.257 and P.258 are used to start the inverter gradually without impact. And varying degrees of S pattern acceleration/deceleration curve are adjusted by the values. When the S pattern acceleration/acceleration curve is started, the inverter will accelerate/decelerate with different speed according to the primary acceleration/deceleration time.
- 2) When S pattern acceleration/deceleration curve 3 is selected, the acceleration/ deceleration time will be longer, as follows.
- 3) When the selected acceleration time (P.7 or P.44) \geq P.255 and P.256, the actual acceleration time is as follows:
The actual acceleration time = The selected acceleration time + (P.255 + P.256) / 2
- 4) When the selected deceleration time (P.8 or P.45) \geq P.257 and P.258, the actual deceleration time is as follows:
The actual deceleration time = The selected deceleration time + (P.257 + P.258) / 2

Example: When the parameters are initial value (60 Hz system), the actual acceleration time from 0Hz to 60Hz in accordance with S pattern acceleration/deceleration curve 3 is as follows:

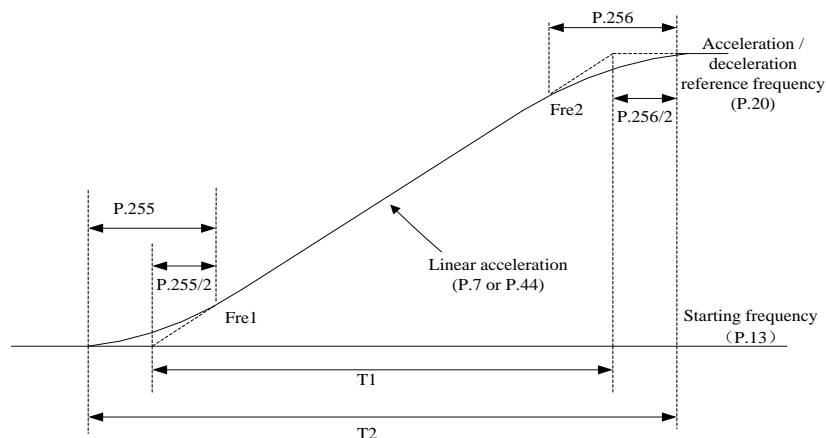

The acceleration time being set $T1 = (P.20 - P.13) * P.7 / P.20$
 The actual acceleration time $T2 = T1 + (P.255 + P.256) * (P.20 - P.13) / 2 / P.20$
 So $T1 = (60 - 0.5) * 5 / 60 = 4.96s$ (the actual acceleration time of linear acceleration)
 The actual acceleration time $T2 = 4.96 + (0.2 + 0.2) * (60 - 0.5) / 2 / 60 = 5.16s$

Note: All calculations of acceleration/deceleration time are base on P.20.

5.14 Regenerative Brake (P.30, P.70)

P.30 “Regenerative brake function selection”

P.70 “Special regenerative brake duty”

- Changing the output frequency from high to low will cause the motor speed to be greater than the output frequency of the inverter due to load inertia and thereby inducing the generator effect. In this case, a high voltage will exist between the main-circuit terminals +/P and -/N and damage the inverter. Therefore, a proper brake resistor shall be mounted between terminals +/P and PR to dissipate the feedback energy.
- There is a built-in transistor in the inverter. The conducting time ratio of the transistor is referred to as the regenerative brake duty. The higher the regenerative brake duty is, the more energy the brake resistor consumes, and the stronger the brake capability is.

Parameter	Factory Setting	Setting Range	Remarks	
30	0	0~1	0	If regenerative brake duty is 3% fixed, the value of parameter 70 is invalid.
			1	The regenerative brake duty is the value of parameter 70 setting.
70	0	0~30%	---	

Note: 1. In occasions where frequent start/stop occurs, a high capacity brake resistor is required.
 2. For brake resistor options, please refer to [Section 3.6.3](#).

5.15 Soft-PWM Selection (P.31)

P.31 “Soft-PWM selection”

- **Soft-PWM** is a method for eliminating motor noises.

Parameter	Factory Setting	Setting Range	Remarks
31	0	0	No action
		1	Soft-PWM selected when $P.72 < 5$, this function is only valid under the V/F mode.
		2	The rated current is kept, and actual carrier is reduced according to the module temperature. When $P.72 > 9$, if inverter module temperature is higher than 60°C, carriers frequency will automatically reduce to 9K, after the module temperature falling to lower than 40°C, carrier frequency will automatically restore the P.72 setting value.

5.16 Communication Function (P.32, P.33,P.34, P.36, P.48~P.53, P.153~P.154)

P.32 “Serial communication Baud rate selection”

P.33 “Communication protocol selection”

P.34 “Communication EEPROM writing selection”

P.36 “Inverter station number”

P.48 “Data length”

P.49 “STOP bit length”

P.50 “Parity check selection”

P.51 “CR & LF selection”

P.52 “Number of communication retries”

P.53 “Communication check time interval”

P.153 “Communication error handling”

P.154 “Modbus communication data format”

Parameter	Factory Setting	Setting Range	Remarks	
32	1	0~3	0	Baud rate: 4800bps
			1	Baud rate: 9600bps
			2	Baud rate: 19200bps
			3	Reserved
33	1	0, 1	0	Modbus protocol
			1	Shihlin protocol
34	0	0,1	0	Writing parameter through communication into EEPROM and RAM
			1	Writing parameter through communication into RAM
36	0	0~254	(Note 1)	
48	0	0, 1	0	Data length: 8 bit
			1	Data length: 7bit
49	0	0~1	0	STOP bit length: 1 bit
			1	STOP bit length: 2 bit
50	0	0~2	0	Not Given
			1	Odd
			2	Even

Parameter Description

Parameter	Factory Setting	Setting Range	Remarks	Parameter
51	1	1~2	1	Only CR
			2	CR and LF
52	1	0~10	(Note 2)	
53	9999	0~999.8s, 9999	0~999.8s	Conduct communication overtime test according to the set value
			9999	9999: No communication overtime test (Note 3)
153	0	0, 1	0	Warn and call to stop
			1	No warning and keep running
154	4	0~5	0	Modbus ASCII mode, Protocol<1,7,N,2> (Note 4)
			1	Modbus ASCII mode, Protocol<1,7,E,1>
			2	Modbus ASCII mode, Protocol<1,7,O,1>
			3	Modbus RTU mode, Protocol<1,8,N,2>
			4	Modbus RTU mode, Protocol<1,8,E,1>
			5	Modbus RTU mode, Protocol<1,8,O,1>

- Reset the inverter after revising communication parameters.
- The SS2-type inverters have two optional communication protocols: Shihlin protocol and Modbus protocol. Corresponding P.32, P.36, P.52, P.53, and P.153 are applied to both protocols. P.48~P.51 is only applied to the Shihlin protocol while P.154 is only applied to Modbus protocol.
- When changing the parameter values frequency through RS485 terminals, set "1" in P. 34 to write them to the RAM. The life of the EEPROM will be shorter if parameter write is performed frequently with the setting unchanged from "0 (initial value)" (EEPROM write).
- When P. 34 is set to "1" (only RAM write), the new values of the parameters will be cleared at power supply-off of the inverter. Therefore, the parameter values available when power is switched ON again are the values stored in EEPROM previously.

Note: 1.The wiring method and matching resistance determines the number of inverters controlled by the communication interface of the host computer. Once Modbus protocol is selected, please set P.33 to none zero values.

2. If the time of communication errors exceeds the set value of P.52 while P.153 is set to 0, alarm will be activated and the screen of DU06 will display *OPF*.

3. When P.53=9999, there is no time limit.

4. For Modbus protocol, protocol 1 is the start bit; 7 is the data bits; No is the parity bit; 2 is the stop bit; N means no parity; E means 1-bit even parity; and O means 1-bit odd parity.

1. Shihlin protocol

- Automatic ASCII code (hexadecimal) conversion for communication between PC and the inverter.
- Follow the steps below for data communication between the inverter and the computer.

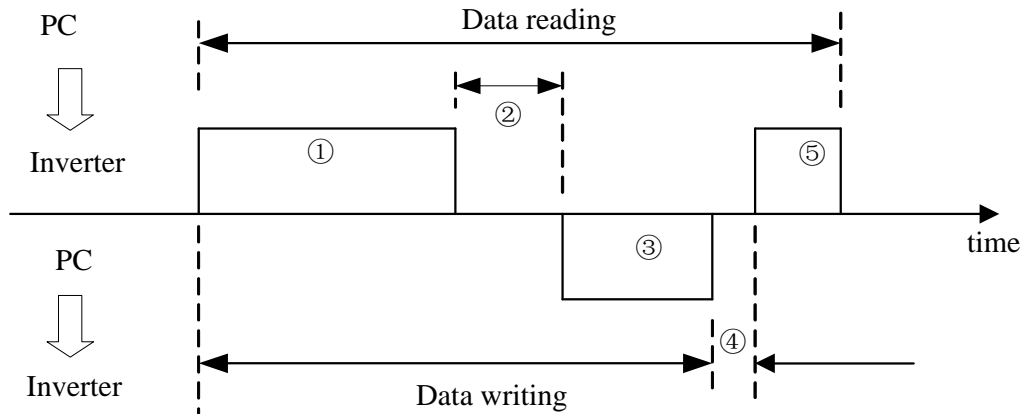

Steps for different communication type with or without data format:

No.	Description	Operation Command	Operation Frequency	Write Parameter	Reset	Monitoring	Read Out Parameter	
①	Computer sends out communication request to inverter	A	A	A	A	B	B	
②	Inverter Data Processing time	yes	yes	yes	no	yes	yes	
③	Data responded from inverter (check errors of ①)	No error (request accepted)	C	C	C	no	E	E
		Error (request rejected)	D	D	D	no	D	D
④	Computer data processing time	no	no	no	no	no	no	
⑤	Data responded from computer (check errors of ③)	No error (no process)	no	no	no	no	C	C
		Error (output③)	no	no	no	no	F	F

① Communication requests from computer to inverter

Format	Information number													
	1	2	3	4	5	6	7	8	9	10	11	12	13	14
A (Write data to Inverter)	ENQ *1)	Station Number		Command Code		Waiting Time *2)	Data				Sum Check *7)		Stop Character *3)	
B (Read data from Inverter)	ENQ *1)	Station Number		Command Code		Waiting Time *2)	Sum Check *7)		Stop Character *3)					

Parameter Description

③ Data transmission from the computer to inverter; inverter's data responses

• Write data

Format	Information Number					
	1	2	3	4	5	6
C (Data no error)	ACK *1)	Station Number		Stop Character *3)		
D (Data error)	NAK *1)	Station Number		Error Code *5)	Stop Character *3)	

• Readout data

Format	Information Number												
	1	2	3	4	5	6	7	8	9	10	11	12	13
E (Data no error)	STX *1)	Station Number		Readout Data				Unit *4)	ETX	Sum Check *7)		Stop Character *3)	
D (Data error)	NAK *1)	Station Number		Error Code *5)	Stop Character *3)								

⑤ Inverter's responding data when the computer performs data reading

Format	Information number				
	1	2	3	4	5
C (No data error)	ACK *1)	Station Number		Stop Character *3)	
F (Data error)	NAK *1)	Station Number		Stop Character *3)	

*1) Description of Control Codes (ASCII CODE)

Control Code	ASCII CODE	Description	Control Code	ASCII CODE	Description
NUL	H00	NULL	ACK	H06	Acknowledge
STX	H02	Start of Text	LF	H0A	Line Feed
ETX	H03	End of Text	CR	H0D	Carriage Return
ENQ	H05	Enquiry	NAK	H15	Negative Acknowledge

*2) Waiting time is set between 0 and 15, and the unit is 10ms; for example, 5 denotes 50ms.

*3) Stop Character (CR, LF CODE)

For data communication between the computer and the inverter, packet the last CR and LF codes by the automatic setup of the computer. The inverter of the PC must be set up. If only CR is selected, only one register is needed. If both CR and LF are chosen, two registers have to be included.

Parameter Description

*4) Unit: 0 denotes that the unit is 1; 1 denotes that the unit is 0.1; 2 denotes that the unit is 0.01; 3 denotes that the unit is 0.001.

*5) Error Code:

Error Code	Error Item	Communication error exception content
H01	Error	Parity check: What the inverter has received is different from the initial set.
H02	Sum Check Error	Inverter side of the calculation of the received data value Sum Check and the Sum Check which received are different.

Error Code	Error Item	Communication error exception content
H03	Protocol Error	The information the inverter received is a syntax error, or the information is not received within the specified time, or CR and LF codes are different from the initial set.
H04	Frame Error	The STOP bit the inverter received is different from the initial set.
H05	Overflow Error	The inverter has not received the data for PC to write the incoming data.
H0A	Mode Exceptions	The inverter is running or is not at a correct operation mode for writing.
H0B	Command Code Error.	The input command codes cannot be handled by the inverter.
H0C	Data Range Error	The set parameter and frequency data are outside the specified range.

*6) When the parameters have 9999 properties, write or read HFFFF instead of 9999.

*7) Sum check code

ASCII data transformation code: Add a binary code. The result (sum) of the next bit (the low 8-bit) is transformed into a 2-bit ASCII code (hexadecimal), which is referred to as the Sum Check Code.

● Communication examples

Example 1. The computer sends a forward command to the inverter:

Step1. FA commands sent by the computer using format A:

ENQ	Station Number	Command Code	Waiting Time	Data	Sum Check	CR
	0	HFA		H0002		
H05	H30 H30	H46 H41	H30	H30 H30 H30 H32	H44 H39	H0D

Calculation Sum Check: $H30 + H30 + H46 + H41 + H30 + H30 + H30 + H30 + H32 = H1D9$; Take the lower 8 bits D9 to convert to ASCII code: H44 H39

Step2. The inverter responds to the computer using format C after receiving and processing the data:

ACK	Station number	CR
	0	
H06	H30 H30	H0D

Parameter Description

Example 2. The computer sends a stop command to the inverter:

Step1. FA commands sent by the PC via format A:

ENQ	Station Number 0	Command Code HFA	Waiting Time	Data H0000	Sum Check	CR
H05	H30 H30	H46 H41	H30	H30 H30 H30 H30	H44 H37	H0D

Step2. The inverter responds to the computer using format C after receiving and processing the data:

ACK	Station Number 0	CR
H06	H30 H30	H0D

Example 3. PC communication for reading P.195:

Step1. PC sends inputting page change command to the inverter via format A:

ENQ	Station Number 0	Command Code HFF	Waiting Time	Data H0001	Sum Check	CR
H05	H30 H30	H46 H46	H30	H30 H30 H30 H31	H44 H44	H0D

↓
P.195 is in page 1

Step2. After receiving and processing the data, the inverter responds to the computer via the format C:

ACK	Station Number 0	CR
H06	H30 H30	H0D

Step3. The computer requests the inverter to read the value of P.195 via format B:

ENQ	Station Number 0	Command Code H5F	Waiting Time	Sum Check	CR
H05	H30 H30	H35 H46	H30	H30 H42	H0D

↓

First, deduct 100 from 195 and get 95. Next, invert 95 to hexadecimal H5F. Finally, convert 5 and F to ASCII CODE H35 and H46.

Step4. After the inverter receiving the information and processes it correctly, the inverter will send the value of P.195 to the computer via format E:

STX	Station Number 0	Read Data H1770(60Hz)	Unit	ETX	Sum Check	CR
H02	H30 H30	H31 H37 H37 H30	H32	H03	H36 H31	H0D

Example 4. Change the value of P.195 to 50 (the initial value is 60):

Step1 and 2 of this example are similar to Step1 and 2 of Example 3.

Parameter Description

Step 3. The computer requests the inverter to enter 50 into P.195 via format A:

ENQ	Station Number 0	Command Code HDF	Waiting Time	Data H1388	Sum Check	CR
H05	H30 H30	H44 H46	H30	H31 H33 H38 H38	H45 H45	H0D

- ↓

1) Deduct 100 from 195 and get 95.
Convert 95 to hexadecimal H5F.
Add H5F to H80 and get HDF.

↓

1) The minimum unit of P.195 is 0.01, therefore the product of 50 and 100 is 5000.
2) Convert 5000 to hexadecimal H1388. Convert 1, 3, 8, 8 to ASCII CODE before data transmission.

Step 4. The inverter responds to the computer using format C after receiving and processing the data.

ACK	Station Number 0	CR
H06	H30 H30	H0D

Example 5. Change the value of P.195 to 500 (parameter range 0~400):

Step1 and step 2 of Example 5 are similar to Step1 and Step2 of Example 3.

Step 3. The computer requests the inverter to enter 500 into P.195 via format A:

ENQ	Station Number 0	Command Code HDF	Waiting Time	Data HC350	Sum Check	CR
H05	H30 H30	H44 H46	H30	H43 H33 H35 H30	H46 H35	H0D

Step 4. After processing, the inverter will send feedbacks about the out of range data (i.e., incorrect data) to the computer via format D:

NAK	Station Number 0	Error Code H0C	CR
H15	H30 H30	H43	H0D

2. Modbus protocol

1). Information form

- Modbus serial transmission can be divided into two kinds: ASCII (American Standard Code for Information Interchange) and RTU (Remote Terminal Unit) modes.

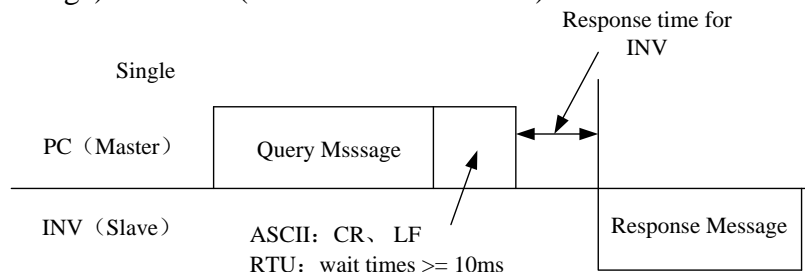

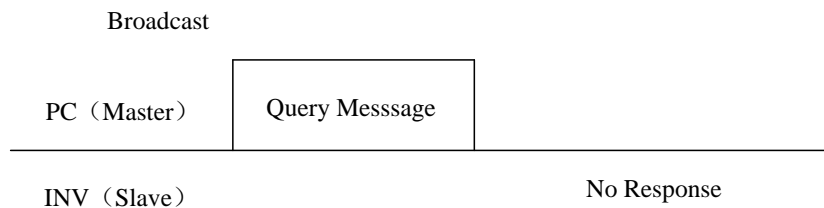

(1). Query

The computer (primary address) sends a message to the inverter (from the address) with the specified address.

(2). Normal response

After receiving the query from the computer, the inverter performs the requested function from the computer and return to the normal function.

(3). Error response

If the inverter receives an invalid function code, address, or data, it will send feedback to the computer.

The computer designated by address 0 can send a message to all the inverters. All inverters that receive information from the computer will perform the requested function, but they do not send feedback to the computer.

2). Communication format

- Main frame transmit the query message to the inverter, and the inverter responds to the message from the PC. The address and function code will be copied during normal communication. Bit 7 of the function will be set to 1 (=H80), and Data Byte will be set by the error code if the communication is abnormal.
- Message form:

Mode	Start	①Address	②Function	③Data	④Error check	End
ASCII	H3A	8 Bit	8 Bit	n×8 Bit	2×8 Bit	0D 0A
RTU	>=10ms					>=10ms

Message	Details
① Address	<p>Setting range: 0~254. 0 is the broadcast address, and address of the inverter ranges between 1 and 254.</p> <p>P.36 can set the address of inverter. P.36 must be set for the computer to send information from the inverter and the inverter sends feedback to the computer.</p>

② Function	SE2-type inverters have three functions. The inverter operates according to the command from the computer. The computer set up functions of the table other than the code, the inverter will send an error feedback to the computer. Response returned from the inverter in normal response returns to normal function. When an error feedback is sent, the function code should add H80.		
	Function Name	Function Code	Details
	Read multiple registers	H03	PCs or PLCs may read straight registers from inverters.
	Write single register	H06	PCs or PLCs may write a single register to inverters.
	Function diagnosis	H08	Function diagnosis (only for communication calibration)
	Write multiple registers	H10	From the PC may write straight registers to inverter.
③ Data	Data can be changed according to the function code. Data include the start address, the number of register and the write message.		
④ Check Error	ASCII mode is for the LRC checksum and RTU mode is for the CRC checksum. (In LRC, please refer to the standard Modbus protocol specification for detailed CRC checksum algorithm instructions).		

Algorithm of LRC checksum:

LRC check is relatively simple. It is at the ASCII mode for detecting messages except the beginning of the colon field and the end of the carriage return line number. It only needs to transmit the data of each byte stack, and if the result is greater than hexadecimal H100, after removal of the excess (such as: the results obtained for the hexadecimal H136, only to take H36) can be reversed then plus 1.

Algorithm of CRC checksum:

1. Installation of a 16-bit register and all bits are 1.
2. The 16-bit operation result, an exclusive OR between the 16-bit register high byte, and the beginning of 8-bit byte, was put into the register.
3. The 16-bit register shifts 1-bit towards the right.
4. If the first digit on the right-hand side (mark bit) is 1, the exclusive OR is between the generator polynomial 1010000000000001 and the register operated. If the first digit on the right-hand side is 0, then go back to Step 3.
5. Repeat Step 3 and 4, until there is no more 8-bit.
6. Let exclusive OR between another 8-bit and this 16-bit register.
7. Repeat Step 3 to 6 until all bytes of the packet have exclusive OR, the 16-bit register, and have been shifted eight times.
8. The 2-byte CRC error checking of the 16-bit registers is added to the most significant bit of the message.

To add CRC to the message, start from the low byte to the high byte.

Parameter Description

● Communication format

(1). Read data (H03)

Mode	Start	Address *1)	Function *2)	Initial Address *3)	Register Number *4)	Check	End
ASCII	H3A	2char	2char	4char	4char	2char	0D 0A
RTU	>=10ms	1byte	1byte	2byte	2byte	2byte	>=10ms

Normal response

Mode	Start	Address *1)	Function *2)	Read Data Number *5)	Read Data *6)	Check	End
ASCII	H3A	2char	2char	2char	...2N×1char	2char	0D 0A
RTU	>=10ms	1byte	1byte	1byte	...2N×1byte	2byte	>=10ms

Message	Content
*1) Address	Set the address for the information to be sent to. 0 is none.
*2) Function code	H03
*3) Initial address	Set to the address of the register to be read.
*4) Register number	Set to the number of the register to be read (less than 12 registers).
*5) Read data	Repeat *4).
*6) Read data	Set information specified in * 4). Read the data byte by the order.

(2). Write data (H06)

Mode	Start	Address *1)	Function *2)	Initial Address *3)	Write Data *4)	Check	End
ASCII	H3A	2char	2char	4char	4char	2char	0D 0A
RTU	>=10ms	1byte	1byte	2byte	2byte	2byte	>=10ms

Normal response

Mode	Start	Address *1)	Function *2)	Initial Address *3)	Write Data *4)	Check	End
ASCII	H3A	2char	2char	4char	4char	2char	0D 0A
RTU	>=10ms	1byte	1byte	2byte	2byte	2byte	>=10ms

Message	Content
*1) Address	Set the address for the information to be sent to.
*2) Function code	H06
*3) Initial address	Set the beginning address of the register to be written.
*4) Write dada	Write the data onto the specified register that is fixed as 16-bit.

Note: Message of normal response is the same as the query information.

Parameter Description

(3).Function Diagnosis (H08)

By sending a query information, and getting the same query information back (the function of the subroutine code H00), it can do communication calibration.

The subroutine code H00 (for inquiring the return of data)

The query information

Mode	Start	Address *1)	Function *2)	Subroutine *3)	Data *4)	Check	End
ASCII	H3A	2char	2char	4char	4char	2char	0D 0A
RTU	>=10ms	1byte	1byte	2byte	2byte	2byte	>=10ms

Normal response

Mode	Start	Address *1)	Function *2)	Subroutine *3)	Data *4)	Check	End
ASCII	H3A	2char	2char	4char	4char	2char	0D 0A
RTU	>=10ms	1byte	1byte	2byte	2byte	2byte	>=10ms

Setting of the query information

Information	Content
*1) Address	Set the address for the information to be sent to, not able to radio communications(0 invalid)
*2)Function code	H08
*3)Subroutine code	H0000
*4) Data	If the data is 2 byte, it can be set arbitrarily. Set range from H0000 to HFFFF.

(4). Write Multiple Registers (H10)

Mode	Start	Address *1)	Function *2)	Initial Address *3)	Register Number *4)	Data Quantity *5)	Write Data *6)	Check	End
ASCII	H3A	2char	2char	4char	4char	2char	...2N×1char	2char	0D 0A
RTU	>=10ms	1byte	1byte	2byte	2byte	1byte	...2N×1byte	2byte	>=10ms

Normal response

Mode	Start	Address *1)	Function *2)	Initial Address *3)	Register Number *4)	Check	End
ASCII	H3A	2char	2char	4char	4char	2char	0D 0A
RTU	>=10ms	1byte	1byte	2byte	2byte	2byte	>=10ms

Parameter Description

Message	Content
*1) Address	Set the address for the information to be sent.
*2) Function code	H10
*3) Initial address	Set the beginning address of the register that has a writing function.
*4) Register number	Set the number of register for writing (less than 12 registers).
*5) Data quantity	Set the range between 2 and 24. Repeat *4).
*6) Write data	Set data specified in *4). Write the data according to the Hi byte and Lo byte order to set and follow the starting address of the data. The starting addresses +1 of the data, the starting address +2 of the data ... to set the order.

(5). Abnormal response

Abnormal There will be no errors if one or more addresses can be operated when they are accessed by the function code H03 or H10. obtained because the query information received from the inverter is incorrect in terms of the function, address and data.

There will be no errors if one or more addresses can be operated when they are accessed by the function code H03 or H10.

Mode	Start	Address *1)	Function *2) H80+ Function code	Error Code *3)	Check	End
ASCII	H3A	2char	2char	2char	2char	0D 0A
RTU	>=10ms	1byte	1byte	1byte	2byte	>=10ms

Message	Content
*1) Address	Set the address for the information to be sent to.
*2) Function code	Function code+H80
*3) Error code	Set the code from the following table.

List of error codes:

Resource	Code	Meaning	Remarks
Inverter Response	H01	Invalid function code	The inverter can not handle the code from the query message issued by the computer. H03, H06, H08 and H10 are the function codes.
	H02	Invalid data address	The inverter can not handle address coming from the query message issued by the computer. (For addresses not listed in the table, retention parameters, parameters cannot be used to read and write.)
	H03	Invalid data	The inverter can not handle the data coming from the query message issued by the computer. (There is a specified mode and errors when the data are outside the writing range of the parameters.)

Note: Reading more than one parameters, even reading the retention parameters, are not considered as an error.

Parameter Description

The following errors in the data issued by the computer can be detected by the inverter, but there is no feedback from the inverters for detecting errors.

Error detection list:

Error item	Error content
Parity error	Parity received by the inverter is different from the initial set of the inverter.
Frame error	The stop bit lengths of the data that the inverter has received do not match to the initial set of stop bits of the inverter
Overflow error	When the inverter has not yet received the data but the computer starts to write the incoming data.
Check error	The inverter's data calculated according to the received LRC / CRC check result is inconsistent with the received LRC / CRC checksum.

• Communications examples

Example 1. Write CU (communication) mode by Communication

Step 1. Modify the inverter mode by the computer

Mode	Start	Address	Function	Initial Address		Write Data		Check	End
ASCII	H3A	H30 H31	H30 H36	H31H30	H30 H30	H30 H30	H30 H30	H45 H39	0D 0A
RTU	>=10ms	01	06	10	00	00	00	8D 0A	>=10ms

Step 2. The inverter responds to the computer after receiving and processing the data,

Mode	Start	Address	Function	Initial Address		Write Data		Check	End
ASCII	H3A	H30 H31	H30 H36	H31H30	H30 H30	H30 H30	H30 H30	H45 H39	0D 0A
RTU	>=10ms	01	06	10	00	00	00	8D 0A	>=10ms

Example 2. Read computer communication P.195:

Step 1. PC requests the inverter to read the value of P.195. The address of P.195 is H00C3.

Mode	Start	Address	Function	Initial Address		Register Number		Check	End
ASCII	H3A	H30 H31	H30 H33	H30H30	H43 H33	H30 H30	H30 H31	H33 H38	0D 0A
RTU	>=10ms	01	03	00	C3	00	01	74 36	>=10ms

Step 2. After the inverter receives the data and processes the data without encountering errors; the inverter will send the value of P.195 to the computer.

Mode	Start	Address	Function	Read Data Number	Read Data		Check	End
ASCII	H3A	H30 H31	H30 H33	H30 H32	H31 H37	H37 H30	H37 H33	0D 0A
RTU	>=10ms	01	03	02	17	70	B6 50	>=10ms

H1770 into decimal is 6000, the unit of P.195 is 0.01. $6000 \times 0.01 = 60$, which is the value of P.195.

Parameter Description

Example 3. Change the value of P.195 to 50

Step 1. The computer requests the inverter to input 50 into P.195.

Mode	Start	Address	Function	Initial Address		Write Data		Check	End
ASCII	H3A	H30 H31	H30 H36	H30H30	H43 H33	H31 H33	H38 H38	H39 H42	0D 0A
RTU	>=10ms	01	06	00	C3	13	88	74 A0	>=10ms

Step 2. After receiving and processing the data, the inverter sends feedbacks to the computer.

Mode	Start	Address	Function	Initial Address		Write Data		Check	End
ASCII	H3A	H30 H31	H30 H36	H30H30	H43 H33	H31 H33	H38 H38	H39 H42	0D 0A
RTU	>=10ms	01	06	00	C3	13	88	74 A0	>=10ms

Example 4. Message from the computer for reading parameters from P.0 to P.11:

Step 1. The computer requests the inverter to read the value of P.0~P.11. The initial address is H0000.

Mode	Start	Address	Function	Initial address		Register number		Check	End
ASCII	H3A	H30 H31	H30 H33	H30H30	H30 H30	H30 H30	H30 H43	H46 H30	0D 0A
RTU	>=10ms	01	03	00	00	00	0C	45 CF	>=10ms

Step 2. After receiving and processing the data, the inverter sends feedback to the computer.

Mode	Start	Address	Function	Number of Read Data		Read Data	Check	End
ASCII	H3A	H30 H31	H30 H33	H31 H38		...24×1 char	2char	0D 0A
RTU	>=10ms	01	03	18		...24×1 byte	2byte	>=10ms

Example 5. Messages from the computer for writing parameters from P.0 to P.11:

Step 1. The computer requests the inverter to write the value of P.0~P.11.

Mode	Start	Address	Function	Mode		Register Number		Data Quantity	Write Data	Check	End
ASCII	H3A	H30 H31	H31 H30	H30 H30	H30 H30	H30 H30	H30 H43	H31 H38	...2N×1 char	2char	0D 0A
RTU	>=10ms	01	10	00	00	00	0C	18	...2N×1 byte	2byte	>=10ms

Step 2. After receiving and processing the data, the inverter sends feedbacks to the computer.

Mode	Start	Address	Function	Initial Address		Register Number		Check	End
ASCII	H3A	H30 H31	H31 H30	H30H30	H30 H30	H30 H30	H30 H43	H45 H33	0D 0A
RTU	>=10ms	01	10	00	00	00	0C	00 18	>=10ms

3. Communication command list

- Set following command codes and data to control various operations, monitoring and so on.

Modbus code	Item	Shihlin Protocol Code	Information Content and Functions	Modbus Address
H03	Read out operation mode	H7B	H0000: Communication mode; H0001: External mode; H0002: JOG mode; H0003: H1, H3, H5; H0004: H2, H4	H1000
H06/H10	Write operation mode	HFB		
H03	Special monitor select codes read out	H7D	H0000~H000C: Monitor selected information Special monitor select read out codes as described in the special monitoring code table	H1013
H06/H10	Special monitor select codes write in	HF3		

Modbus Code	Item		Shihlin Protocol Code	Information Content and Functions	Modbus Address			
H03	Inverter State		H7A	H0000~H00FF b8~b15: reserved b7: Alarm occurrence b6: Frequency detection b5: Parameters to default values end. b4: Overload b3: Frequency achieved b2: Reverse rotation b1: Forward rotation b0: Operation	H1001			
H03	Monitoring	Set frequency	EEPR OM RAM	H73	H0000~HFDE8	H1009		
				H6D		H1002		
		Output frequency		H6F	H0000~HFDE8	H1003		
		Output current		H70	H0000~HFFFF	H1004		
		Output voltage		H71	H0000~HFFFF	H1005		
		Alarm item			H74	H0000~HFFFF:	H1007	
						H74/H1007: Error code 1 and 2		b15 b8 b7 b0
						Error code 2		
H75/H1008: Error code 3 and 4	b15 b8 b7 b0							
Error code 4		Error code 3	H1008					
Error code can reference the <u>table</u> in alarm history parameters.								

Parameter Description

H06/H10	Operation command		HFA	H0000~HFFFF b8~b15: reserved b7: scram (MRS) b6: 2 nd Acceleration/Declaration Selection(RT) b5: High Speed (RH) b4: Mid Speed (RM) b3: :Low Speed (RL) b2: REV Rotation(STR) b1: FWD Rotation (STF) b0: reserved	H1001										
H06/H10	Inverter reset		HFD	H9696: The function of P.997 Communicate with the computer: the inverter can not send data back to the computer because it has been reset.	H1101										
Modbus Code	Item		Shihlin Protocol Code	Information Content and Functions	Modbus Address										
H06/H10	Operation frequency write in	EEPROM	HEE	H0000~HFDE8: 0~650HZ	H1009										
		RAM	HED		H1002										
H06/H10	Inverter parameter and error code erased.		HFC	See parameter recovery description table	H5A5A	H1104									
					H9966	H1103									
					H9696	H1106									
					H55AA	H1105									
					HA5A5	H1102									
H03	Monitor the external operation condition		H7C	H0000~H000F: <table border="1" style="margin-left: auto; margin-right: auto;"> <tr> <td style="text-align: center;">b15~b4</td> <td style="text-align: center;">b3</td> <td style="text-align: center;">b2</td> <td style="text-align: center;">b1</td> <td style="text-align: center;">b0</td> </tr> <tr> <td style="text-align: center;">0000 0000 0000</td> <td style="text-align: center;">MRS</td> <td style="text-align: center;">STR</td> <td style="text-align: center;">STF</td> <td style="text-align: center;">RES</td> </tr> </table>	b15~b4	b3	b2	b1	b0	0000 0000 0000	MRS	STR	STF	RES	H1012
b15~b4	b3	b2	b1	b0											
0000 0000 0000	MRS	STR	STF	RES											

Parameter Description

H03	Monitor the INV real-time data	---	<p>The corresponding monitoring value of each Modbus Address is as follows:</p> <p>H1014: external terminal input state</p> <p>H1015: external terminal output state</p> <p>H1016: 2-5 terminal input voltage</p> <p>H1017: 4-5 terminal input current/voltage</p> <p>H1018: AM-5 terminal output voltage</p> <p>H1019: DC bus voltage</p> <p>H101A: rate of heat accumulated by inverter electronic</p> <p>H101B: inverter output power</p> <p>H101C: rate of temperature rising accumulated by inverter</p> <p>H101D: temperature of inverter module</p> <p>H101E: rate of the heat accumulated by motor electronic</p> <p>H101F: target pressure when PID control</p> <p>H1020: feedback pressure when PID control</p>	H1014 ~ H1012
-----	--------------------------------	-----	---	---------------------

Modbus Code	Item		Shihlin Protocol Code	Information Content and Functions	Modbus Address
H03	Parameter read out		H00~H63	P.0~P.499; for the range and decimal point, please refer to the parameter list. Every parameter modbus address is the 16 band parameter number. For example: the modbus address of <u>P.138</u> is H008A.	H0000 H01F3
H06/H10	Parameter write in		H80~HE3		
---	Write/read Parameter page change	Read	H7F	H0000: P.0~P.99; H0001: P.100~P.199; H0002: P.200~P.299; H0003: P.300~P.399; H0004: P.400~P.499.	---
		Write	HFF		

Parameter Description

● Parameter recovery description table

Data content	P operating	Communication Parameters (Note)	except <u>P.21</u> , <u>P.187~P.199</u> , <u>P.292</u> , <u>P.293</u> , <u>P.300~P.309</u> and Communication Parameter	Another Parameters	Error Code
H5A5A	P.999	o	o	x	x
H9966	P.998	o	o	o	x
H9696	Communication 999	x	o	x	x
H55AA	Communication 998	x	o	o	x
HA5A5	P.996	x	x	x	o

Note: Communication parameters include P.32, P.33, P.36, P.48~P.53, P.79, P.153 and P.154.

● The table of the special monitor code

Information	Content	Unit
H0000	Monitor the external terminal input port state.	Note1
H0001	Monitor the external terminal output port state.	Note2
H0002	Monitor the voltage which can be input across terminal 2-5.	0.01V
H0003	Monitor the voltage/current which can be input across terminal 4-5.	0.01A/0.01V
H0004	Monitor the voltage which can be output across terminal AM-5.	0.01V
H0005	Monitor the busbar voltage value.	1V
H0006	Monitor the electronic thermal rate	---
H0007	The rate of temperature rising accumulated by inverter	---
H0008	The inverter output power	0.01KW
H0009	The temperature of inverter module	---
H000A	The rate of heat accumulate by motor electronic	---
H000B	Target pressure when PID control	0.1%
H000C	Feedback pressure when PID control	0.1%

Note: 1. Details of the external terminal input port state.

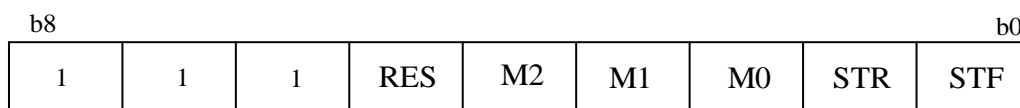

2. Details of the external terminal output port state.

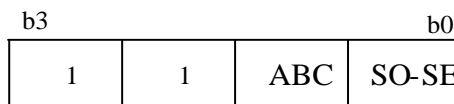

5.17 Communication Running and Speed Command (P.35)

P.35 “Communication Running and Speed Command Selection”

Parameter	Factory Setting	Setting Range	Remarks
35	0	0,1	---

<Setting>

- In P.79=3 communication mode, if P.35=1, it will turn to be communication external mode when running command and set frequency are given by the external terminals.

5.18 Speed Display (P.37, P.259)

P.37 “Speed display”

P.259 “Speed unit selection”

- At the output frequency monitoring mode, the screen will display the corresponding mechanical speed.

Parameter	Factory Setting	Setting Range	Remarks	
37	0 r/min	0~5000.0r/min	0	Output frequency
			0.1~5000.0r/min	P.259=1
		0~9999 r/min	1~9999 r/min	P.259=0
259	1	0, 1	---	

<Setting>

- The set value of P.37 is the mechanical speed of the inverter when its output frequency is 60Hz. If P.37 is needed to be set to 9999, please set P.259 to 0 before setting P.37.
For example: If the transmitting belt speed is 950 m/minute when the inverter output frequency is 60Hz, P.37 shall be set to 950. At the output frequency monitoring mode, the screen will display the speed of the transmitting belt.

Note: 1. There maybe are discrepancies (in minutes) between the displayed mechanical speed and the actual one.
 2. Please refer to [Section 4.1](#) for detailed operation for the operation panel working mode.
 3. When P.259=0 and the output mechanical speed is more than 9998, the screen will display 9999, and the maximum speed of inverter won't exceed 65535; when P.259=1 and the output speed is more than 999.9, the screen will only display the part of intger number, and the maximum speed of inverter won't exceed 6553.5

5.19 Voltage Signal Selection and Target Frequency (P.38, P.73, P.139~P.141)

P.38 “The maximum operation frequency (the target frequency is set by the input signal of terminal 2-5)”

P.73 “Voltage signal selection”

P.139 “Voltage signal bias”

P.140 “Voltage signal gain”

P.141 “Voltage signal bias direction and rotational direction setup”

Parameter	Factory Setting	Setting Range	Remarks
38	50Hz	1~650Hz	When P.189=1
	60Hz		When P.189=0
73	1	0, 1	0 The range for the input voltage signal (terminal 2-5) is 0~5V.
			1 The range for the input voltage signal (terminal 2-5) is 0~10V.
139	0%	0%~200%	---
140	100%	0.1%~200%	---
141	0	0~11	---

< Setting >

- P.141 has two digits, and each digit has its distinct meaning. Their relevant positions are presented as follows:

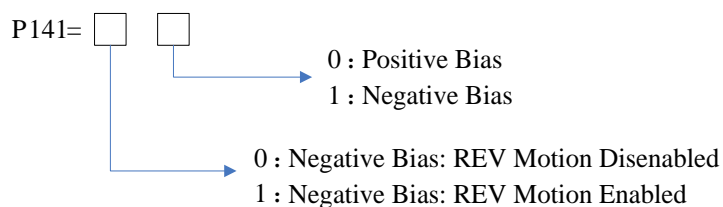

- Set the frequency by using negative bias benefits to significantly avoid noise interference. In harsh environments, the user is advised to avoid using the actuator signal, which is below 1V of the operating frequency.

Here are some examples:

Example 1: This is the most used setting. When the inverter is at the external mode, the combined mode 2 or the combined mode 4, the frequency is set by terminal 2-5.

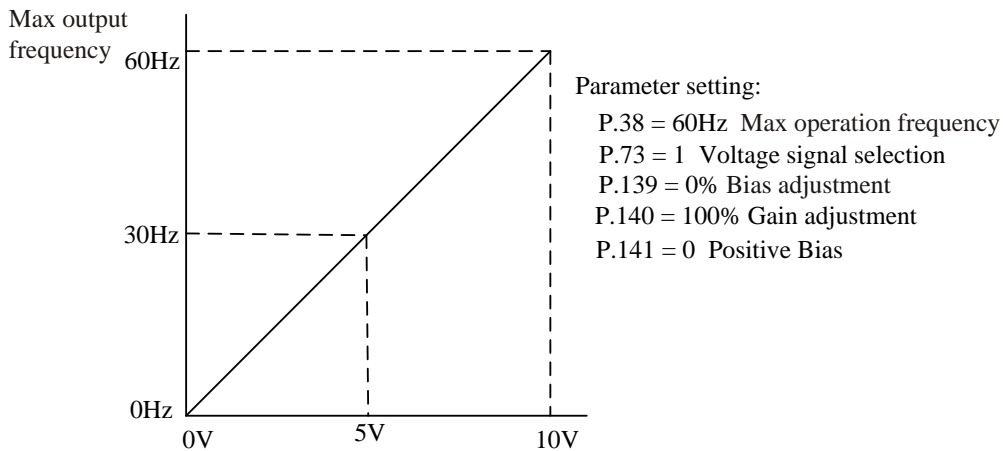

Example 2: This example shows the effect of changing the bias. When the input is 0V, the output frequency is 10 Hz. At the mid-point, the potentiometer will give 40 Hz. Once the maximum output frequency is reached, any further increase of the potentiometer or signals will not increase the output frequency. To use the full potentiometer range, please refer to Example 3. The value of external input voltage/current 0~8.33V corresponds to the setting frequency 10~60Hz.

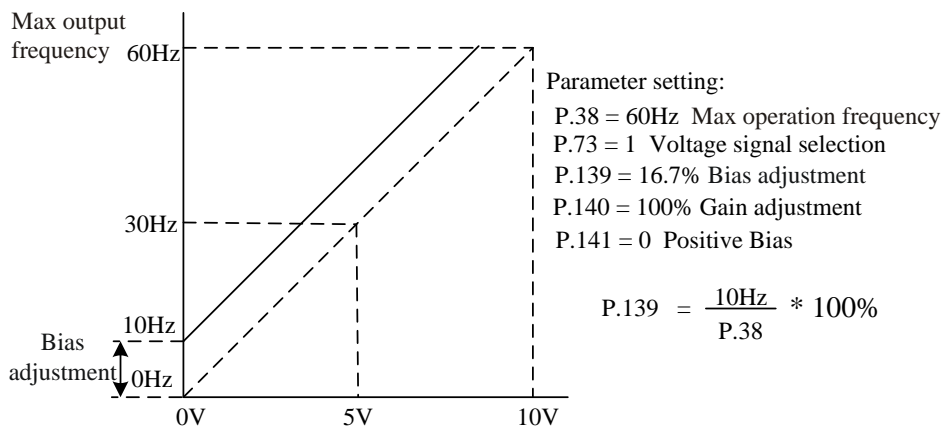

Example 3: This is another frequently used method. The whole scale of the potentiometer can be used as desired.

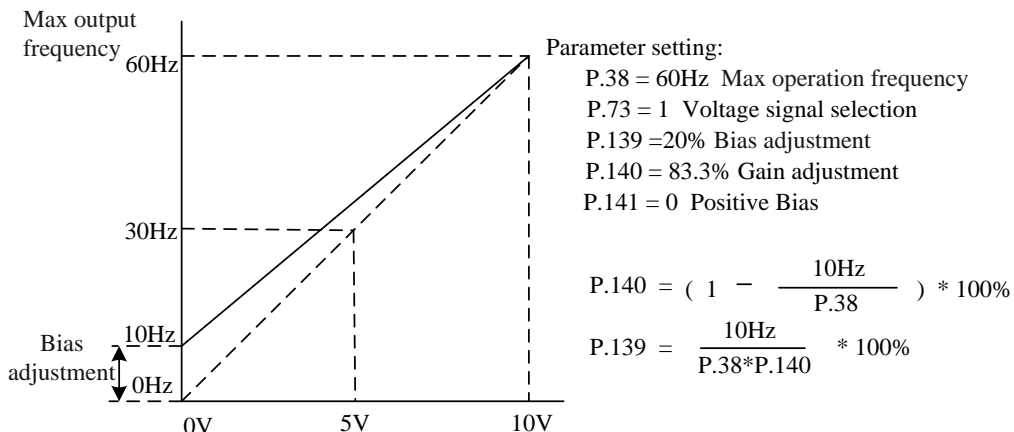

Example 4: This example shows a potentiometer range between 0V and 5 V. Instead of adjusting gain as the example below, the user can set P.38 to 120Hz or P.73 to 0 to achieve the same result.

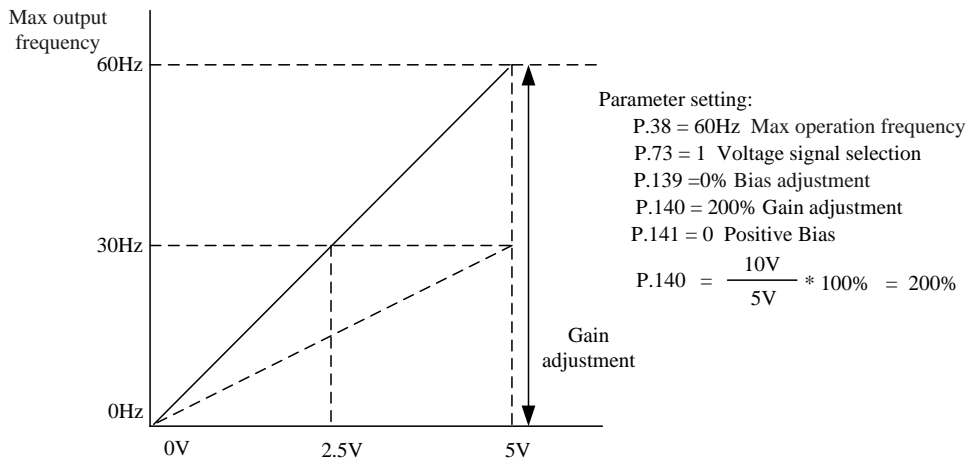

Example 5: In this example, a 1V negative bias is used. In a noisy environment, it is advantageous to use the negative bias to provide a noise margin (1V in this example).

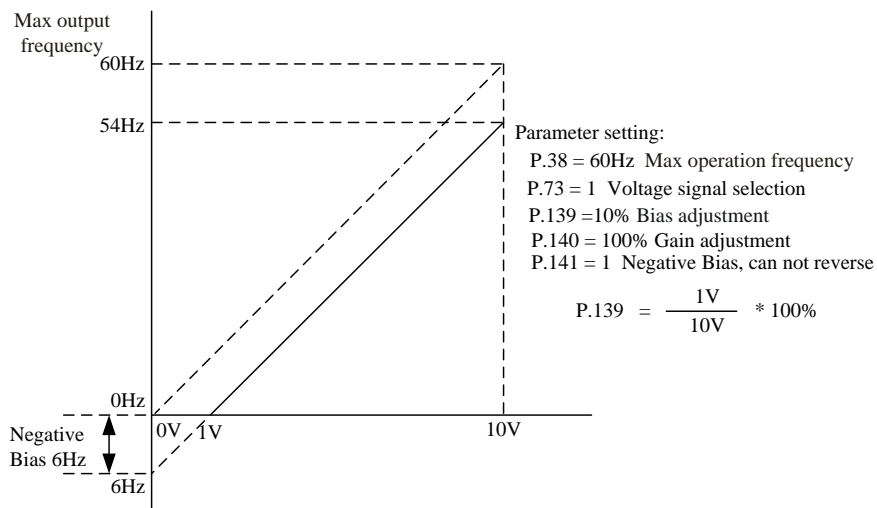

Example 6: In this example, a negative bias is used to provide a noise margin. Also a potentiometer frequency gain is used to reach the maximum output frequency.

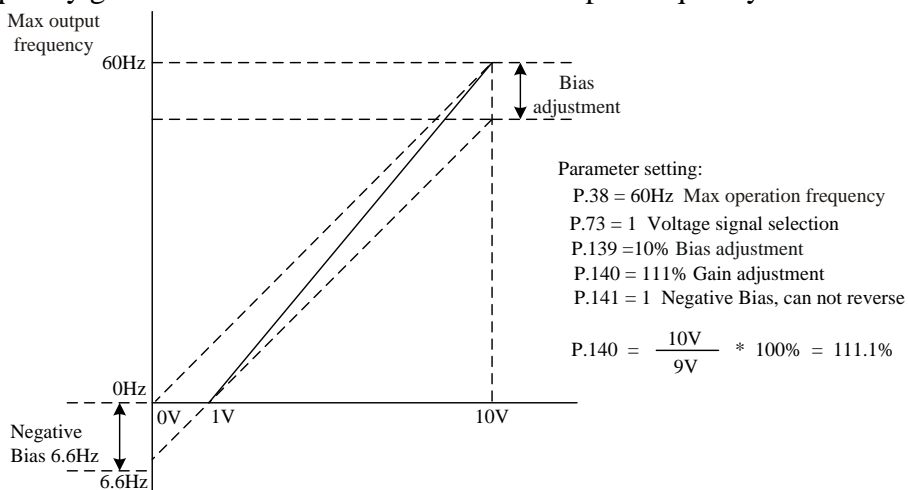

Example 7: In this example, the input is programmed to run a motor in both forward and reverse directions. The motor will idle when the potentiometer position is at the mid-point of the scale. Using the settings in this example to disable the external FWD and REV controls.

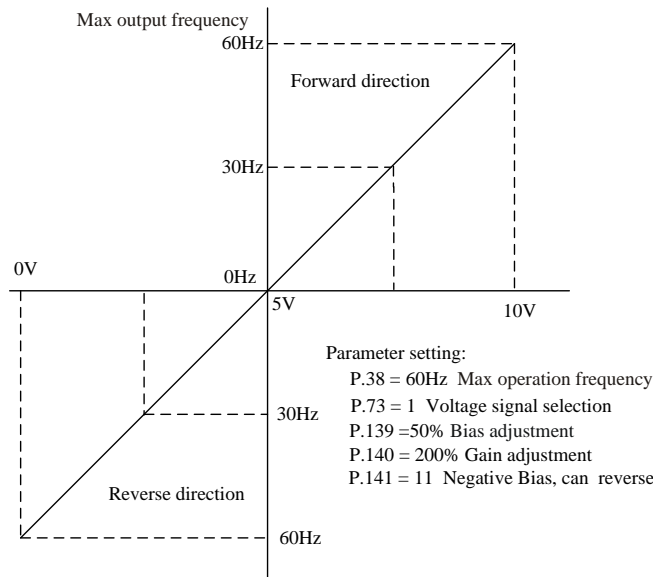

Example 8: This example shows the use of negative slope. Negative slopes are used for controlling pressure, temperature or flow. The input-connected sensor generates a large signal (10V) at high pressure or flow. At negative slope settings, the AC motor drive will slowly stop the motor. With these settings, the AC motor drive will run in one direction (reverse) only. This can only be changed by exchanging the two wires of the motor.

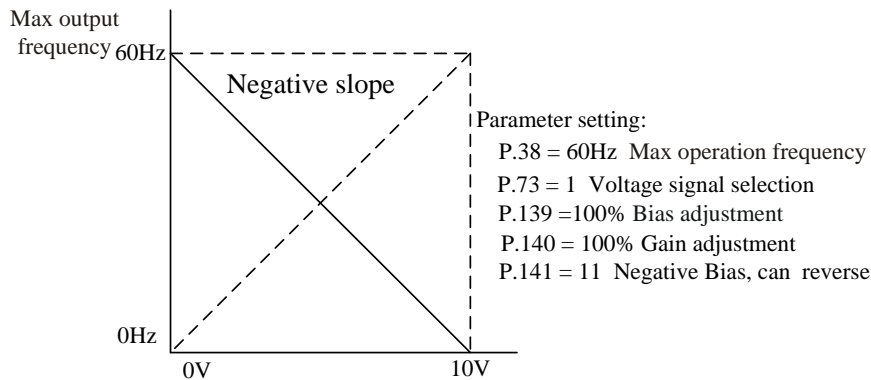

Note: 1. At the external mode, combined mode 2 or combined mode 4, the inverter target frequency is set by the input signal across terminal 2-5/4-5 if RH, RM, RL and REX are all off. If AU is on, the input signal across terminal 4-5 will have a higher priority.

2. RL, RM, RH, REX, AU and RUN are the function names of the multi-function control terminals. For the corresponding functions for selection and features, please refer to [P.80~P.84](#), [P.86](#). For wiring, please refer to [Section 3.5.6](#).

5.20 The Input Signal across Terminal 4-5 and the Target Frequency (P.17, P.39)

P.17 “Input signals across terminal 4-5 selection”

P.39 “The maximum operation frequency (the target frequency is set by the input signal of terminal 4-5)”

- SS2-TYPE series inverters have two analog input channels, terminal 2-5 and terminal 4-5. Only voltage signals can across terminal 2-5, but both voltage signals and current signals can across terminal 4-5. The function of the terminal 4-5 determined by P.17 and the switch AVI/ACI.
- The set value of P.39 is the target frequency value of the inverter when the input signal of terminal 4-5 is 20mA or 5V (10V). The input signal across terminal 4-5 can switch by the P.17 and the switch AVI/ACI. When the AVI/ACI switched to ACI and P.17=0, the current signal across terminal 4-5. When the AVI/ACI switched to AVI, the voltage signal across terminal 4-5, if P.17=2, the range is 0~5V, if P.17=1, the range is 0~10V.

Parameter	Factory Setting	Setting Range	Remarks	
17	0	0~2	0	Current signal valid
			1	0~10V voltage signals across terminal
			2	0~5V voltage signals across terminal
39	50Hz	1~650Hz	P.189=1	
	60Hz		P.189=0	

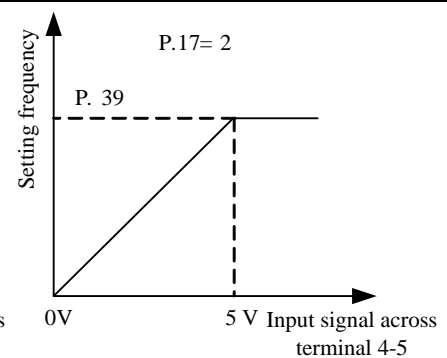
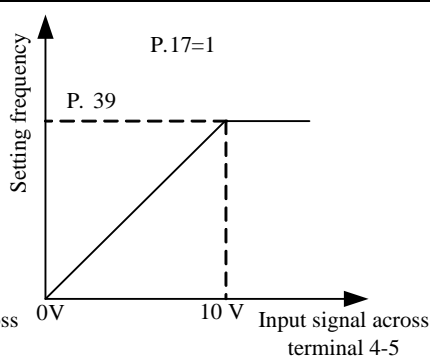
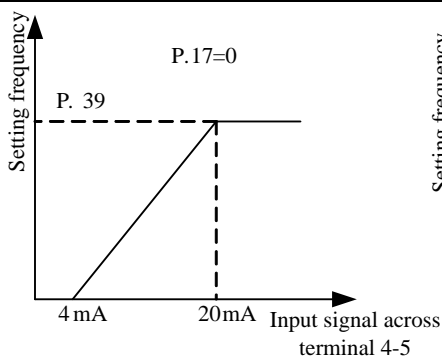

Note: 1. At the external mode, the combined mode 2 or the combined mode 4, the target frequency of the inverter is set by the input signal of terminal 4-5 if AU is on.

2. At the external mode, the combined mode 2 or the combined mode 4, the multi-speed has higher priority if AU and one of RH, RM, RL and REX are both valid.

3. RL, RM, RH, REX and AU are the function names of the multi-function control terminal. For the corresponding function of selection and features, please refer to P.80~P.84, P.86. For wiring, please refer to Section 3.5.6.

5.21 Multi-function Output (P.40, P.64, P.74, P.85, P.120 and P.187)

P.40 “Multi-function output terminal pattern”

P.64 “Pulse output selection”

P.74 “10X output selection”

P.85 “Function selection for multi-function relay”

P.120 “Output signal delay time”

P.187 “FM calibration parameter”

Related parameters

- P.41 “Up-to-frequency sensitivity”
- P.42 “Output frequency detection for forward rotation”
- P.43 “Output frequency detection for reverse rotation”
- P.62 “Zero current detection level”
- P.63 “Zero current detection time”

Parameter	Factory Setting	Setting Range	Remarks
40	0	0~12, 17,18,41	---
64	0	0, 1	P.64=0, P.74=0: SO function
74	0	0~10	P.64=1, P.74=0: FM function P.64=1, P.74=1~10: 10X function
85	5	0~12, 17,18,41	---
120	0s	0~3600s	---
187	220	0~9998	The calibrating values, therefore the default value for each machine may differ slightly.

< Setting >

- When set different value to P40/P.85, the function of the SO-SE (SO function)/A-B-C terminal is below:

Parameter	function
P.40/P.85	0 RUN (Inverter running): Signal will be output when the output frequency is equal to or higher than the starting frequency.
	1 SU (Up to frequency): Signal will be output once the output frequency has reached the set region of frequency.
	2 FU (Output frequency detection): Signal will be output once the output frequency has reached or exceeded the detection frequency set.
	3 OL (Overload detection): Signal will be output once the current limit function is triggered. (About OL2 detection, please refer to over torque detection selection P.260)
	4 OMD (Zero current detection): If the output current percentage of the inverter is less than the set value of <u>P.62</u> , and lasts for the pre-defined time (the setting value of <u>P.63</u>), OMD will output signal.
	5 ALARM (Alarm detection): Alarm detection
	6 PO1 (Section detection): At the programmed operation mode, PO1 signal will be output in the end of each section.

Parameter	function	
P.40/P.85	7	PO2 (Periodical detection): At the programmed operation mode, PO2 signal will be output at the end of each cycle.
	8	PO3 (Pause detection): At the programmed operation mode, PO3 signal will be output when the inverter pauses.
	9	BP (Inverter output): Switch between the inverter operation and commercial power-supply operation function. During the inverter operation, BP will output signals.
	10	GP (Commercial power-supply output): Switch between the inverter operation and commercial power-supply operation function. During the commercial power-supply operation, GP will output signals.
	11	OMD1(zero current detection): When the output frequency of inverters reach to the target frequency and the percentage of the output current is lower than the set value of P.62, OMD1 will output signal after a certain time set by P.63.
	12	OL2 (Over torque alarm output): Please refer to over torque detection selection P.260
	17	RY (the inverter running preparation accomplishment): RY signal will be sendout if inverter is in the state of being able to run.
	18	Maintenance Alarm detection
41	PID analog signal feedback loss alarm: (Please refer to analog signal feedback loss action selection P.254)	

- When P.120=0, the signal will be output directly if the set condition of P.40 (P.85) is met.
- When P.120=0.1~3600, the signal will be output after the set time if the set condition of P.40 (P.85) is met.

For example: FU (Output frequency detection) function (For example: P.42/P.43=40Hz)

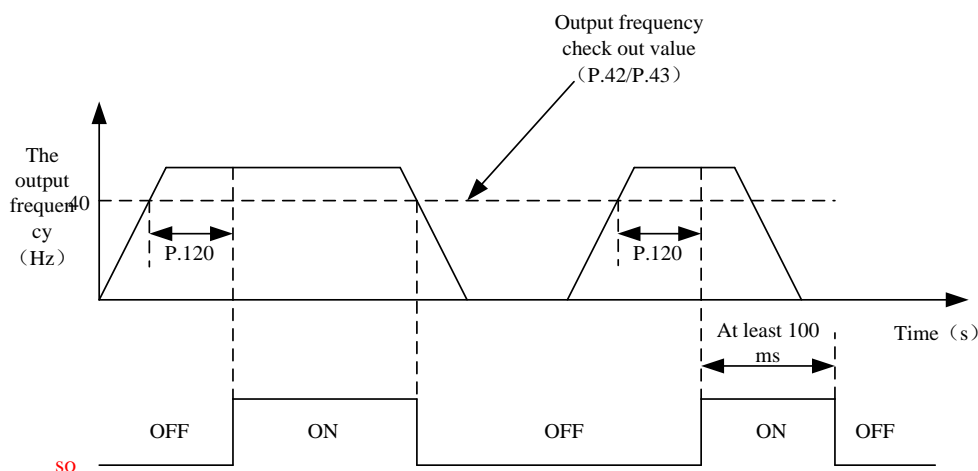

- When P.64=1 and P74=0, the function of external terminal SO is FM function.

The user can insert an electricity meter (current load: 1mA) or a frequency counter between terminal SO and SE to display the output frequency or the output current of the inverter.

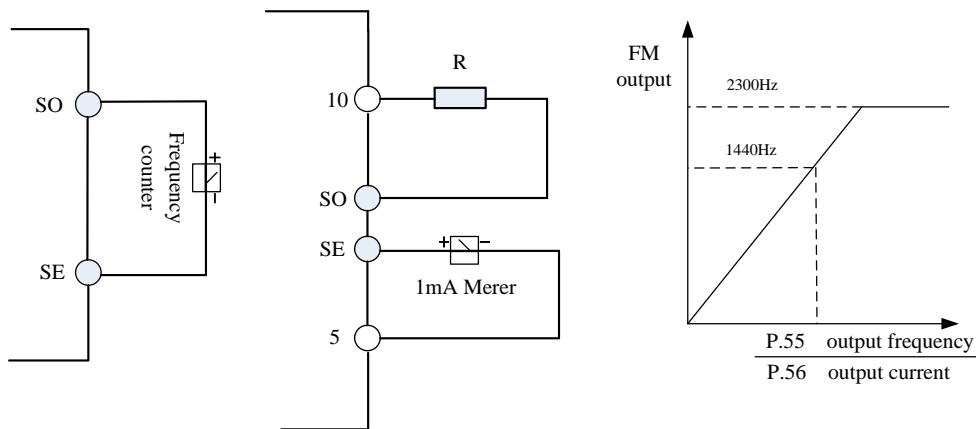

- When P.54=0 and if the output frequency of the inverter is set as P.55, a pulse of 1440 Hz will be produced at terminal SO if FM terminal function is selected.
- When P.54=1 and if the output current of the inverter is set as P.56, a pulse of 1440 Hz will be produced at terminal SO if FM terminal function is selected.
- When P.54=2, the output corresponds to the busbar voltage value. If the voltage between (+/P)-(-/N) reaches the OV alarm level and the function of external terminal SO is FM function, terminal SO will output a 1440Hz pulse.
- When P.54=3, the output corresponds to the accumulation rate of temperature increase of the inverter. If the temperature of the IGBT module of the inverter is too high and reaches the NTC level, the function of external terminal SO will be FM function and a pulse of 1440Hz will be sent out.
- When P.54=4, the output corresponds to the electronic thermal rate. If either the electronic thermal relay (when P.9 ≠ 0) or the electronic thermal relay of the inverter's IGBT module (when P.9 = 0) is running, the function of external terminal SO will be FM function, terminal SO will output a 1440Hz pulse.
- When p.54 = 5, the output corresponding to a set frequency. Set the frequency of frequency converter for p. 55 set value, SO FM function for terminal, terminal SO - SE between the output pulse of 1440 hz
- FM terminal calibration procedures:
 1. Insert an electric meter with a full graduation of 1mA or a frequency counter across terminal SO and terminal SD, and set P.64 to 1, P.54 to 0 and P.74 to 0. Calibrate the header for accessory variation.
 2. Start the motor and fix the output frequency of the inverter to 60 Hz.
 3. When the motor runs steadily, read the set value of P.187. At this point, the screen will display the FM correction index. Turn the keyboard knob Clockwise to adjust the value of P.187. The screen will display a progressively increase of the FM correction index. Press **SET** for more than 0.5 second, and the pointer will move upward. Turn the keyboard knob anticlockwise to adjust the value of P.187 downward, and the screen will display a progressively decrease of the FM correction index. Press **SET** for more than 0.5 second and the pointer will move downward.
- When P.64=1 and P.74=1~10, the function of external terminal SO is 10 times the output function.

• When P.74=5 and temporary running frequency is at 20Hz, we can detect output impulse wave between terminal SO and SE as follows:

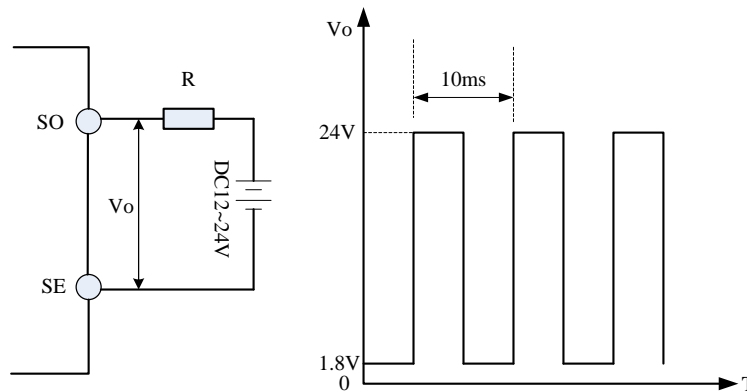

- Note:
1. The multi-function output terminal is SO, When P.40=0 (the default value), it means 'RUN'. When a different value is set, the corresponding function will change according to what is shown in the above table.
 2. The internal electrical structures for the multi-function output terminals are the open collector output. Please refer to Section 3.5.6 and Section 3.5.7 for wiring.
 3. When the set value of P.85 is 5 (the default value), the function of the multi-function relay A-B-C is ALARM. When the value of P.85 is revised, its function changes respectively as the corresponding function listed in the table above.
 4. When setting P.74 to non-zero, SO and FM functions will be invalid.
 5. If the FM function is selected, If the users measured by a frequency counter, the value serious fluctuation, please short SE and 5 terminals.
 6. When P.74=1, the output will be 1-fold. The inverter can provide an output between 1 and 400 Hz with a 1% precision. The larger the rate of P.74, the larger the operation frequency, and the poorer the precision.
 7. Resistor R must be greater than 3~10KΩ.

5.22 Up-to-frequency Sensitivity (P.41)

P.41 "Up-to-frequency sensitivity"

Related parameters

P.40 "Multi-function output terminal pattern"
P.85 "Function selection for multi-function relay"

Parameter	Factory Setting	Setting Range	Remarks
41	10%	0~100%	---

<Setting>

• If P.41=5%, a signal (SU) is output when the output frequency enter the 5% region near the target frequency. For example: the target frequency is set to 60Hz, and P.41=5%, then if the output frequency is between the $60 \pm 60 \times 5\% = 63\text{Hz}$ and 57Hz region, the SU signal is output.

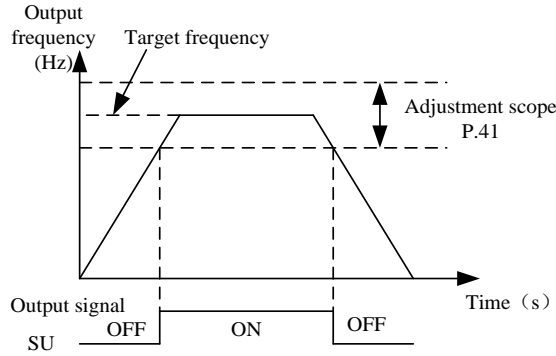

Note: In this paragraph, SU is the function name of the multi-function output terminal. Please refer to [P.40](#) for function selection and features. About wiring, please refer to [Section 3.5.6](#).

5.23 Output Frequency Detection (P.42, P.43)

P.42 “Output frequency detection for forward rotation”

P.43 “Output frequency detection for reverse rotation”

Related parameters

P.40 “Multi-function output terminal pattern”
P.85 “Function selection for multi-function relay”

Parameter	Factory Setting	Setting Range	Remarks
42	6Hz	0~650Hz	---
43	9999	0~650Hz, 9999	9999: same as P.42 setting

<Setting>

- If P.42=30 and P.43=20, then a signal (FU) is output when the forward rotation output frequency exceeds 30Hz or when the reverse rotation output frequency exceeds 20Hz.
- If P.42=30 and P.43=9999 (the default value), then a signal (FU) is output when the forward or reverse rotation output frequency exceeds 30Hz.

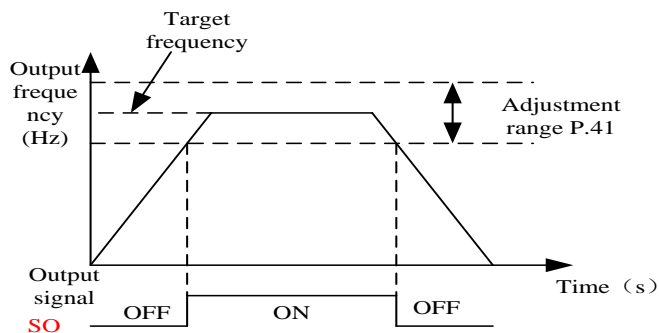

Note: In this section, FU is the function names of the multi-function output terminals. Please refer to [P.40](#) for function selection and features. About wiring, please refer to [Section 3.5.6](#).

5.24 AM Terminal (P.54~P.56, P.190, P.191)

P.54 “AM terminal function selection”

P.55 “Frequency display reference”

P.56 “Current monitoring reference”

P.190 “AM output bias”

P.191 “AM output gain”





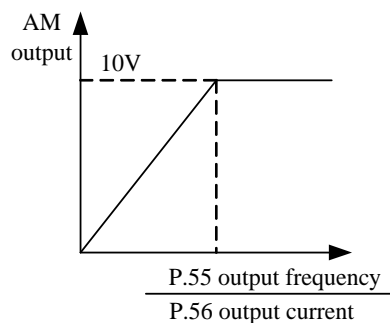

- Between terminal AM and terminal 5, an analog meter can be connected to indicate the output current value or the output frequency.

Parameter	Factory Setting	Setting Range	Remarks
54	0	0~5	---
55	50Hz	0~650Hz	When P.189=1
	60Hz		When P.189=0
56	Rated current	0~500A	---
190	0	0~8192	Parameters P.190 and P.191 are the calibrating values. Therefore the default value for each machine may differ slightly.
191	600	0~8192	

<Setting>

- When P.54=0, a voltage of 10V is output at terminal AM if the output frequency of the inverter is the set value of P.55.
- When P.54=1, a voltage of 10V is output at terminal AM if the output current of the inverter is the set value of P.56.
- When P.54=2, the output corresponds to the busbar voltage value. If the voltage between +/P and -/N reaches the OV alarm level, the terminal AM will output a voltage of 10V.
- When P.54=3, the output corresponds to the accumulation rate of temperature increase of the inverter. If the temperature of the IGBT module of the inverter is too high and reaches the NTC level, a voltage of 10V will be sent out at terminal AM.
- When P.54=4, the output corresponds to the electronic thermal rate. If either the electronic thermal relay (when P.9≠0) or the electronic thermal relay of the inverter’s IGB module (when P.9=0) is running, and a voltage of 10V will be sent out at terminal AM.
- When p. 54 = 5, the output corresponding to a set frequency. Set the frequency of frequency converter for p. 55 set value, terminal AM 10 v output voltage.



- AM terminal checking steps:
 1. Connect an electric meter whose full graduation is 10V between terminal A and terminal 5. Set P.54 to 0, and then check the meter because of the difference of the accessory.
 2. Set P.13 to 0. Start the motor, and fix the output frequency of the inverter at 0Hz.
 3. Read the set value of P.190 and the screen will display the current AM output bias.
 4. Press  and  and hold these bottoms for 0.5s. The finger of the meter moves upwards and the AM output bias will increase. Press  to change the value of P.190, press  and hold for 0.5s. The finger of the meter moves downwards and the AM output bias will decrease. Adjust the scale pointer position to 0 to complete the AM output bias correction work.
 5. Adjust and fix the output frequency of the inverter at 60Hz.
 6. Read the setting value of P.191 and the screen will display the current AM output gain.
 7. Press   to adjust AM output gain, press  and hold for 0.5s, the finger of the meter moves upwards and downwards. When the finger of the meter moves to full range, the checking is completed.

5.25 Restart Function (P.57, P.58, P.150) V/F

P.57 “Restart coasting time”

P.150 “Restart mode selection”

P.58 “Restart cushion time”

Parameter	Factory Setting	Setting Range	Remarks
57	9999	0~30s, 9999	9999: Restart function invalid
58	10s	0~60s	---
150	0	0~22	---

<Setting>

- When the motor is running, the output voltage will not be constant once the driving power is interrupted. When the power is recovered, the inverter will not restart automatically if P.57=9999. If P.57=0.1~5, the motor will coast for a while (the set value of P.57), and then the inverter will restart the motor automatically.
- Once the motor is automatically restarted, the output frequency of the inverter will be the target frequency, but the output voltage will be zero. Then the voltage will be increased gradually to the expected voltage value. The period for the voltage increase is called the Restart cushion time (P.58).

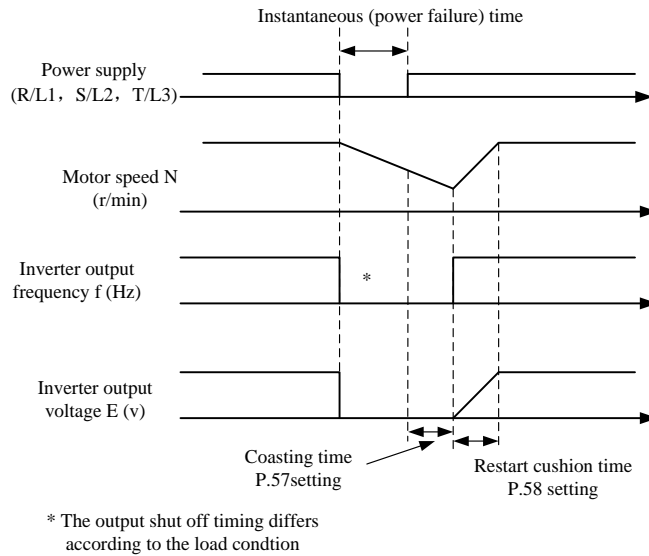

• P.150 has four digits, and each digit has a distinct meaning. Their positions are as following:

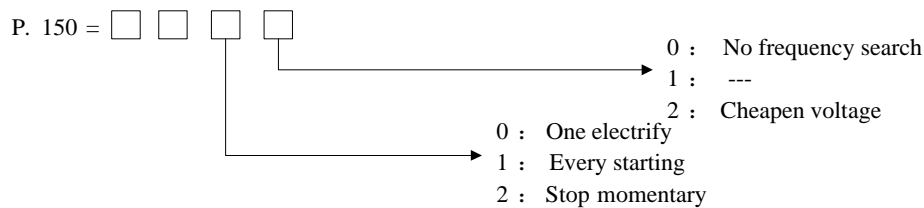

- Note: 1. P.150 must be set when using the restart function,
 2. When the value of P.150 is not 0, default linear acceleration/deceleration curve.
 3. If the single digit of P.150 is 1, P.150 cannot write-in.

5.26 The Choice of Locking Operation Keyboard Knob Setting (P.59)

P.59” The choice of locking operation keyboard knob setting”

Parameter	Factory Setting	Setting Range	Remarks
59	0	0,1,10,11,100,101,110,111,200,201,210,211,1000,1001,1010,1011,1100,1101,1110, 1111,1200,1201,1210,1211	---

- P.59 is set by the digits, and there are 4 digits in total. The meaning of each digit is as follows:

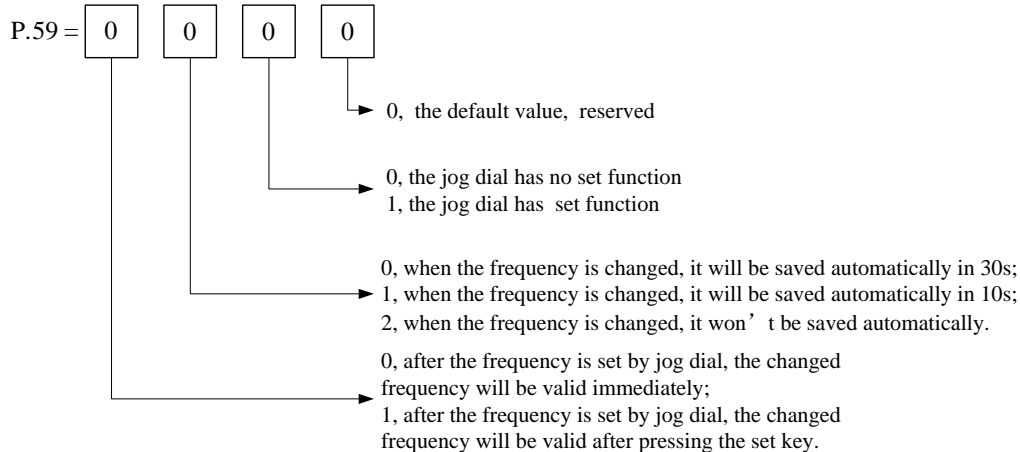

5.27 Input Signal Filter Constant (P.60)

P.60 “Input signal filter constant”

- When the running frequency is set by a voltage signal or a current signal, the voltage or current signal would be processed by an AD converter. Due to the effect of device accuracy or noises, the external voltage signal or current signal may fluctuate and as a result, the running frequency fluctuates, too.
- Input signal filter constant setting P.60 is used to filter the fluctuation of the running frequency caused by above factors. The larger the P.60 set value is, the better the filter performance is, but a larger delay would be resulted in.

Parameter	Factory Setting	Setting Range	Remarks
60	31	0~31	---

5.28 Remote Control Function Selection (P.61, P.219)

P.61 “Remote setting function selection”

P.219 “Remote function acc/dec time selection”

- If the operation box is located away from the control box, contact signals can be used to perform the continuous variable-speed operation without using analog signals at the external mode, the PU mode, the combined mode 1 or the combined mode 5.

Parameter	Factory Setting	Setting Range	Remarks		
			Set Value	Remote Set Function	Frequency Setting Storage Function
61	0	0~4,11~14	0	No	---
			X1	Yes	Yes

			X2		No
			X3		No (The remote setting frequency is cleared by turning off STF/STR.)
			X4	Yes	Remote control function, frequency save in memory every 5s
			1X	Frequency command range 01-01(P.2)~01-00(P.1), frequency command value from RH, RM setting	
P.219	0	0~1	0	Use default acc/dec time (same as regular mode)	
			1	Use second acc/dec time	

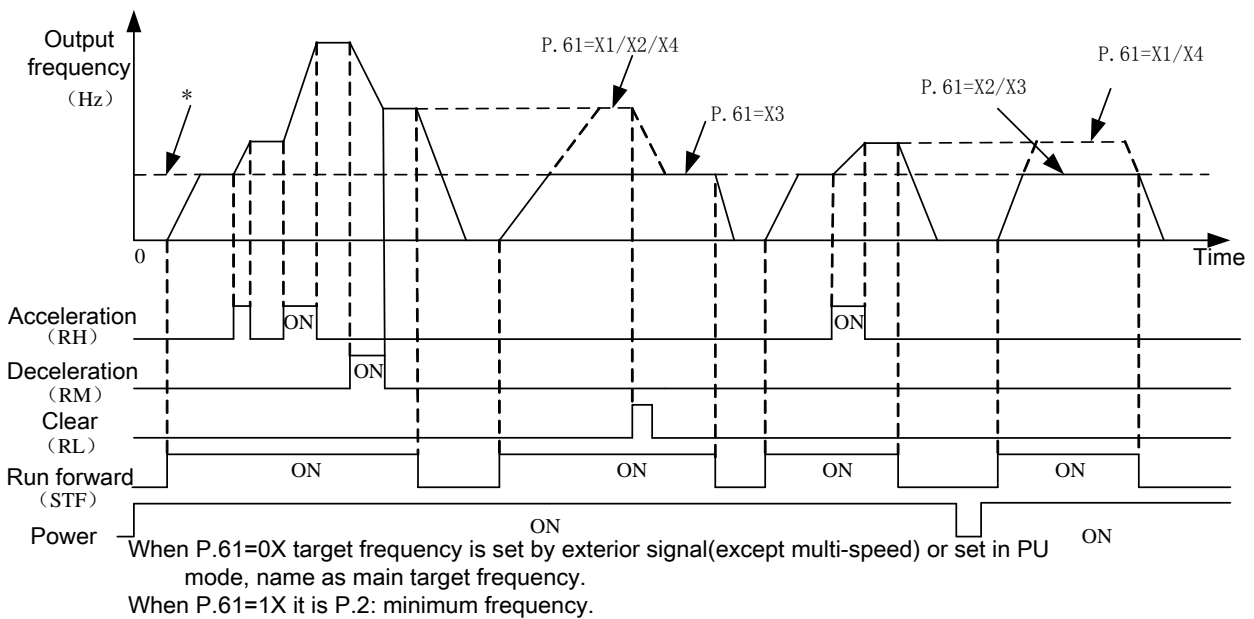

<Setting>

• Remote setting function

- Whether the remote setting function is valid and whether the frequency setting storage function in the remote setting mode is used is selected by P.61.

Set P.61= X1~X4 (remote setting function is valid), the function of terminals RM, RH and RL are changed to acceleration (RH), deceleration (RM) and clear (RL). As shown in the following Figure:

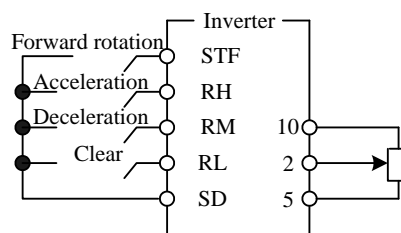

Wiring of remote control setting

2. If 10-11 (P.61)=1~4, the target frequency of inverter = (frequency set during RH and RM operation + external set frequency other than multi-speed/PU set frequency);

If 10-11 (P.61)=11~14, the target frequency of inverter = frequency set during RH and RM operation.

- Frequency setting storage function

The frequency setting storage function is to store the remote-set frequency (frequency set by RH/RM operation) in memory (EEPROM). Once the power supply is shut off, the inverter can start running again at the remote-set frequency (When P.61 = X1/X4).

<Frequency setting storage condition>

10-11(P.61)=X1

The frequency when start signal (STF/STR) is "off";

When RH (acceleration) and RM (deceleration) are both "off", the remote control setting frequency is stored every 1 minute (If RL is triggered will not write);

10-11(P.61)=X4

1. The frequency when RH (acceleration) and RM (deceleration) signals are both "off";

2. Store the remote control setting frequency once every 5s (If RL is triggered will not write);

<Setting>

- Remote control frequency acceleration and deceleration time selection

(1) 01-40 (P.219) = 0, the acceleration and deceleration time of the remote control frequency is the current acceleration and deceleration time (the same as the acceleration and deceleration time of the output frequency);

(2) When 01-40 (P.219) = 1,

If 01-22 (P.44) ≠ 99999, 01-23 (P.45) = 99999, The acceleration time and deceleration of the remote control frequency are both "01-22 (P.44) set value";

If 01-22 (P.44) ≠ 99999, 01-23 (P.45) ≠ 99999, The acceleration time of the remote control frequency is "01-22 (P.44) setting value", and the deceleration time is "01-23 (P.45) setting value";

If 01-22 (P.44) = 99999, the acceleration and deceleration time of the remote control frequency is the current acceleration and deceleration time (the same as the acceleration and deceleration time of the output frequency)

Note: 1. P.61=0X, frequency can be controlled by RH (accelerate) and RM (decelerate) between 0 and (maximum frequency – frequency set by main speed). Output frequency is limited by 01-00(P.1).

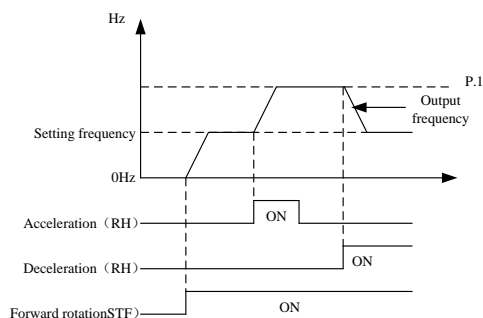

- When 10-11 (P.61) = 1X, the adjustable frequency range through RH (acceleration) and RM (deceleration) is 01-01(P.2)~01-00(P.1), and output frequency is limit by 01-00 (P.1).

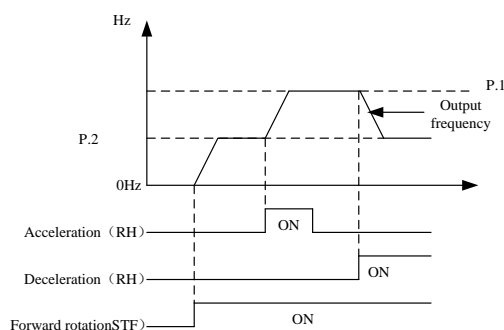

- When acceleration/deceleration signal “on”, acceleration/deceleration time is set by 01-40 (P.219).
- When the start signal (STF/STR) is off, the target frequency will also change if RH (acceleration)/RM (deceleration) is on.
- When the start signal (STF/STR) is changed from on to off, or the frequency is continually changed by RH/RM, make the frequency setting storage function invalid (P.61= X2/X3).If the frequency setting storage function is valid (P.61= X1/X4), the life of the EEPROM will be shortened because of frequent writing of frequency onto EEPROM.
- Signals RH, RM and RL are determined by [P.80~P.84](#), [P.86](#). If the functions of the terminals are changed, other functions are likely to be affected. Please make sure that the functions of the terminals before changing the functions.

5.29 Zero Current Detection (P.62, P.63)

P.62 “Zero current detection level”

P.63 “Zero current detection time”

—Related parameters—

P.40 “Multi-function output terminal pattern”
P.85 “Function selection for multi-function relay”

Parameter	Factory Setting	Setting Range	Remarks
62	5%	0~200%, 9999	9999: Function invalid
63	0.5s	0.05~60s, 9999	9999: Function invalid

<Setting>

- Assume that the rated full-load current of the inverter is 20A, P.62=5%, P.63=0.5s, and the output current is lower than $20 \times 5\% = 1A$ for more than 0.5s, a signal (OMD) is output (as shown in the figure below).

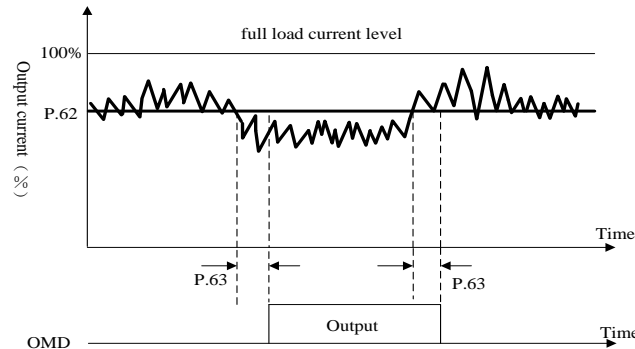

- If the set value of P.62 or P.63 is 9999, the zero current detection is disabled.

Note: In this section, OMD is one of the function names of the multi-function output terminal. Please refer to [P.40](#) for function selection and features, and [Section 3.5.6](#) for wiring.

5.30 Retry (P.65, P.67, P.68, P.69)

P.65 “Retry selection”

P.67 “Number of retries at alarm occurrence”

P.68 “Retry waiting time”

P.69 “Retry accumulation time at alarm”

- When an alarm occurs, previous status before the alarm will be restored automatically, which is called ‘retry’.
- Inverter retry is a conditional execution. For example, when the first alarm occurs, the retry will be executed. A second alarm occurs successively within $P.68 \times 5$ seconds is defined as continuous alarms. The occurrence of a continuous alarm that is more frequent than the pre-defined upper limit indicates a significant malfunction. In this case, special measures should be taken manually and retry will not be executed any more. The number of pre-defined times is called the number of retries at alarm occurrence (P.67).
- If the alarm is not a continuous alarm, the inverter can perform unlimited number of reset.
- The period from the moment of alarm to the retry is defined as the retry waiting time.

Parameter	Factory Setting	Setting Range	Remarks
65	0	0~4	---
67	0	0~10	---
68	6s	0~360s	---

<Setting>

- When P.65=0, retry is invalid. When alarm occurs, the voltage output is stopped, the alarm lamp is lit up, and all the inverter functions are disabled.
- When P.65=1, the voltage output is stopped if the over-voltage between (+P)-(-N) occurs. After a period of waiting time (the set value of P.68), the retry is executed.
- When P.65=2, the voltage output is stopped if over-current occurs. After a period of waiting time (the set value of P.68), the retry is executed.
- When P.65=3, the voltage output is stopped if the over-voltage is between (+P)-(-N) or the over-current occurs. After a period of waiting time (the set value of P.68), the retry is executed.
- When P.65=4, retry is effective. When alarm occurs, the voltage output is stopped. After a period of waiting time (the set value of P.68), the retry is executed.
- When P.67=0, retry is invalid.
- When P.67≠0, given continuous alarm occurs for times within the pre-defined upper limit of P.67, retries will be valid. However, once the upper limit is exceeded, retry is valid no more.
- For each time the retry occurs, the value of P.69 will be increased by one automatically, so the number of P.69 read from the memory indicates the number of retry accumulation time at alarm.
- If P.69 is rewritten with 0, the number of retry executed is erased.

Note: The inverter will retry until the return wait time of P.68 is completed. Therefore, the operation may cause danger if this function is selected. Please be careful.

5.31 Brake Selection (P.71)

P.71 “Idling braking and linear braking selection”

Parameter	Factory Setting	Setting Range	Remarks
71	1	0~1	---

<Setting>

- When P.71=0, the brake is idling. The output of the inverter will be terminated immediately after pressing , and the motor will be racing.

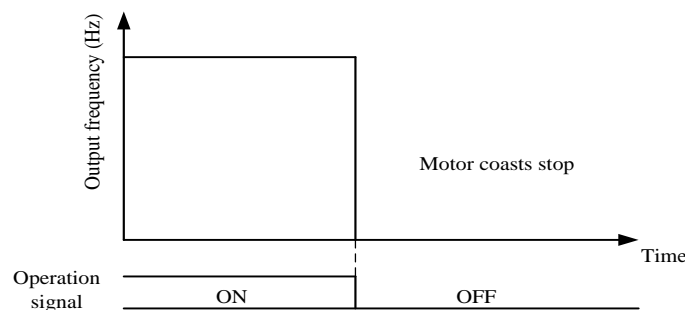

- When P.71=1, it is now beeline brake. The output of the inverter will follow the acceleration/deceleration curve after pressing .

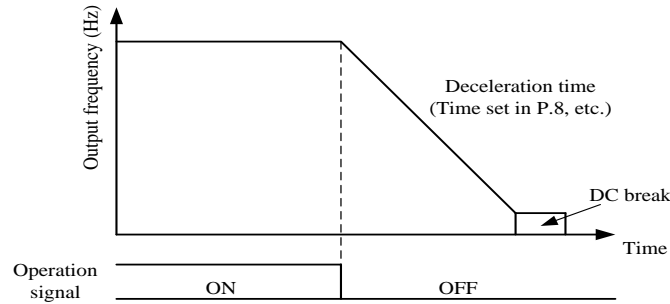

5.32 Carrier Frequency (P.72)

P.72 “Carrier frequency”

Parameter	Factory Setting	Setting Range	Remarks
72	5	1~15	---

<Setting>

- The higher the carrier frequency is, the lower the motor acoustic noise is. Unfortunately, larger leakage current and larger noises generated by the inverter are resulted in.
- The higher the carrier frequency is, the more energy is dissipated, and the higher the temperature of the inverter is.
- In case a mechanical resonance occurs in a system with the inverter, P.72 is helpful for improving the performance by adjusting the values.
- The higher Carrier frequency, the inverter rated current will decline, which was to prevent the inverter to overheat and extend the life of IGBT, so that protection measures are necessary. The carrier frequency is 8kHz or below, rated current of a inverter is 100%, as the carrier frequency increase, rating current will decline, and accelerate product heat to protect the inverter. Rated current and carrier frequency relation curve shown in the following figure:

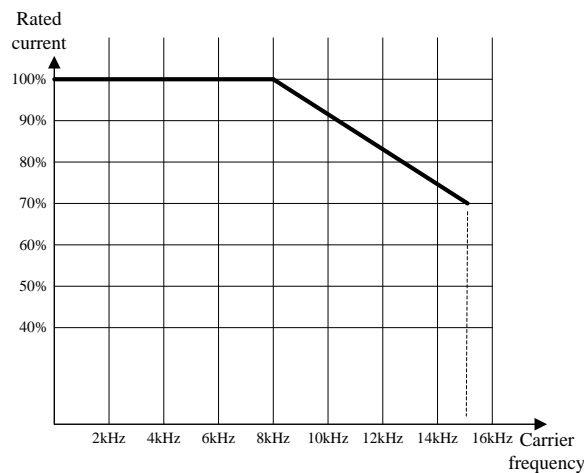



Note: The optimum carrier frequency shall be eight times greater than the target frequency.

5.33 Stop or Reset Function Selection (P.75)

P.75 “Stop or reset function selection”

Parameter	Factory Setting	Setting Range	Remarks
75	1	0, 1	---

<Setting>

- When P.75=0, it is only suitable for the PU mode and the H2 mode (combined mode 2). Pressing  during running can stop the motor.
- When P.75=1, it is only suitable for the chosen mode. Press  during running can stop the motor.

Note: 1. When the alarm goes off, press  for 1 second to reset the inverter. In normal or abnormal conditions, the reset can be executed by P.997.

2. There are two built-in programs for emulation thermal-accumulating relay: the electronic thermal relay and the IGBT module thermal relay. Once reset occurs, the values of the two relay for the electronic thermal relay and the IGBT module thermal relay will be set to zero.

3. In any modes other than the external mode or the H2 mode, the motor can be stopped by pressing  when P.75=1. The inverter would display E0, and all the functions of the inverter are disabled. It can restart by:

- (1). Terminate external STF/STR command (At the programmed operation mode, there's no need to terminate the start signal. The inverter will continue to run at the section where it stopped after reset.)
- (2). Press  for 1.0s.

5.34 Parameters Write Protection (P.77)

P.77 “Parameters write protection”



Parameter	Factory Setting	Setting Range	Remarks
77	0	0~2,4	---

<Setting>

- If P.77=0, all parameters except P.90、P.188、P.289、P.291 can be written when the motor stops. When the motor runs, only P.4~P.6, P.24~P.27, P.54~P.56, P.77, P.131~P.138, P.142~P.149, P.161, P.190~P.199, P.223~P.225, P.230, P.232, P.288 and P.290 can be written.
- If P.77=1, parameter-writing is forbidden except P.77 when the motor runs. When the motor stops, only P.77 and P.79 can be written.
- If P.77=2, all parameters except P.90、P.188、P.289、P.291 can be written when the motor stops. When the motor runs, only P.22, P.72, P.78, P.79, P.155, P.90, P.188, P.289, P.291 can not be written.
- If P.77=4, there is password(P.295). In the condition of lock, other parameters besides P.90、P.188、P.289、P.291、P.294、P.295 can not be read; In the condition of no password or password unlocked, the situation is the same with P.77=0

5.35 Forward/Reverse Rotation Prevention Selection (P.78)

P.78 “Forward/reverse rotation prevention selection”

Parameter	Factory Setting	Setting Range	Remarks	
78	0	0~2	0	Forward rotation and reverse rotation are both permitted.
			1	Reverse rotation is prohibited (Press  to stop the motor).
			2	Forward rotation is prohibited (Press  to stop the motor).

5.36 Operation Mode Selection (P.79)

P.79 “Operation mode selection”

Parameter	Factory Setting	Setting Range	Remarks	
79	0	0~8	0	The PU mode, external mode and JOG mode are valid and interchangeable.
			1	The PU mode and JOG mode are active and interchangeable.
			2	Only the external mode is valid.
			3	Only the communication mode is valid.
			4	Only the combined mode 1 is valid.
			5	Only the combined mode 2 is valid.
			6	Only the combined mode 3 is valid.
			7	Only the combined mode 4 is valid.
			8	Only the combined mode 5 is valid.

Please refer to Section [4.1](#) for details.

5.37 Multi-function Terminals Function Selection (P.80~P.84, P.86)

P.80~P.84, P.86 “Multi-function terminals function selection”

Parameter	Terminal	Factory Setting	Setting Range	Value	Function Name	Function Description	Remarks
80	M0	2	0~40 , 43~45	0	STF	At the external mode, combined mode 1, or combined mode 3, the inverter runs forwards when STF is on.	At the programmed operation mode, it is used as a start signal terminal.
				1	STR	At the external mode, combined mode 1, or combined mode 3, the inverter runs reversely when STF is on.	At the programmed operation mode, it is used as a pause signal terminal.
				2	RL	Multi-speed	Please refer to P.4~P.6
				3	RM	Multi-speed	
				4	RH	Multi-speed	
81	M1	3	0~40 , 43~45	5	AU	At the external mode, combined mode 2 or combined mode 4, the inverter target frequency is set by the signal input across terminal 4-5 when AU is on.	Please refer to P.39
				6	OH	(Note 3)	
				7	MRS	When MRS is turned on, the output terminates.	
82	M2	4	0~41 , 43~45	8	RT	When RT is on, the characteristics are the same as the second function.	Please refer to P.44
				9	EXJ (External JOG)	At the external mode, the target frequency is set by P.15 and the acceleration/ deceleration time is set by P.16 when EXJ is on (Note 4).	

Parameter Description

Parameter	Terminal	Factory Setting	Setting Range	Value	Function Name	Function Description	Remarks
83	STF	0	0~40 , 43~45	10	STF+EXJ	Multiplexed function	The multiplexed function is the complex of several basic functions. It means that one multiplexed terminal can be used to realize several basic functions.
				11	STR+EXJ		
				12	STF+RT		
				13	STR+RT		
				14	STF+RL		
				15	STR+RL		
				16	STF+RM		
				17	STR+RM		
				18	STF+RH		
				19	STR+RH		
				20	STF+RL+RM		
				21	STR+RL+RM		
				22	STF+RT+RL		
				23	STR+RT+RL		
24	STF+RT+RM						
25	STR+RT+RM						
26	STF+RT+RL+RM						
27	STR+RT+RL+RM						
84	STR	1	0~40 , 43~45	28	RUN	At the external mode, the inverter runs when RUN is on.	
				29	STF/STR	At the external mode, it is used with RUN. The inverter runs forwards when STF/STR is on, and runs reversely when STF/STR is off.	Run forward /reverse control signal
				30	RES	External Reset	
				31	STOP	At the external mode, it can be used as a three-wire mode with the RUN signal or the STF/STR terminal (note 4).	
				32	REX	Multi-speed	
				33	PO	At the external mode, programmed operation mode is chosen when PO is on.	
				34	RES_E	When the alarms occur, external Reset became effective	

Parameter Description

Parameter	Terminal	Factory Setting	Setting Range	Value	Name	Function	Instruction
86	RES	30	0~40 , 43~45	35	MPO	At the external mode, manually operation circle mode is chosen when MPO is on.	
				36	TRI	Triangle wave function is chosen when TRI is on.	
				37	GP_BP	Automatic switchover frequency between inverter and commercial power-supply operation	
				38	CS	Manual switch for commercial power-supply.	
				39	STF/STR +STOP	At the external mode, it is used with RUN. The inverter runs reverse when STF/STR is on and stops when STF/STR is off. If you need runs forwards, you should RUN again.	
				40	P_MRS	When P_MRS is turned on, the output stop immediately.	P_MRS is a pulse signal
				41	P_FRE	Frequency set by pulse	Only for terminal M2
				43	RUN_EN	When RUN_EN is turned on, terminals for external operation signal became effective	
				44	PID_OFF	The external terminal stopping PID enable	The signal is sent, PID calculation stops at once
45	SEC_FRE	The second frequency source setting enable	When the signal is valid, the source of frequency is decided according to P.97 setting value.				

Note: 1. The default values are: P.80=2 (RL), P.81=3 (RM), P.82=4 (RH), P.83=0 (STF), P.84=1 (STR), P.86=30 (RES).

- When changing the value of P.80~P.84, P.86, the functions of the terminals will be changed. For example, P.80=2 means that the function of M0 is RL, but if P.80=8, its function changes to RT as a second function selection terminal. P.83=0 means that the STR terminal is chosen as running forward terminal. When P.83=6, its function changes to OH and becomes the external thermal relay terminal.
- External thermal relay (OH) wiring: In traditional wiring, a thermal relay is added to the motor to prevent the motor from being too hot. Its wiring is presented in the right figure. When the external thermal relay is separated, the inverter will induce the alarm, and 'OHT' will be displayed on the screen.

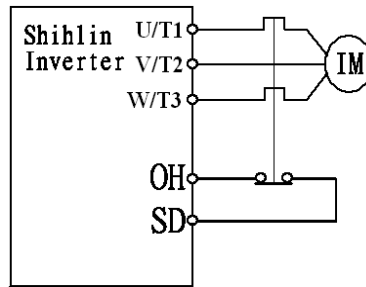

4. There are four kinds of operating modes for driving the inverter ("1" means close terminals, "0" means open terminals, X=0,1,2,3,4,6):

(1) Two-wire control mode 1:

K0	K1	Operating Instructions
0	0	Stop
1	0	Run Forward
0	1	Run Reverse
1	1	Stop

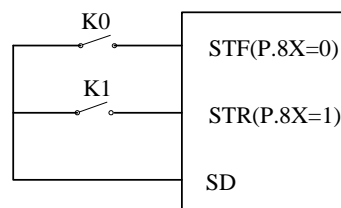

(2) Two-wire control mode 2:

K0	K1	Operating Instructions
0	0	Stop
0	1	Stop
1	0	Run Forward
1	1	Run Reverse

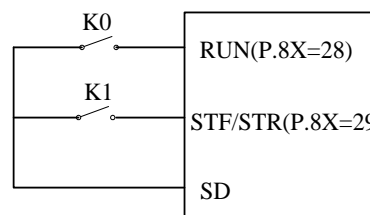

(3) Three-wire control mode 2 (with self maintaining function):K1: STOP signal, normally closed. If it is open, the inverter will stop. K2: RNU signal, normally open, and the pulse signal are active.

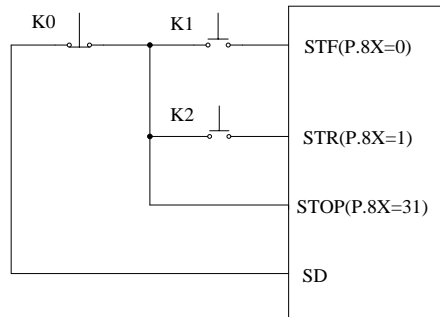

(4) Three-wire control mode2 (with self maintaining function):K1: STOP signal, normally close. If K1 is opened, the inverter will be stopped. K2: RNU signal, normally opened, and the pulse signal is active. If the external terminal corresponds to the parameters settings for 39, the motor will stop until the user starts again when reversing.

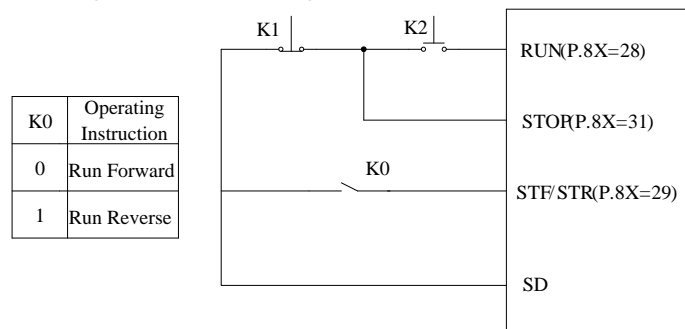

- At the external mode, the programmed operation mode is chosen when PO is on. Terminal STF becomes the start signal. When STF is on, the inverter begins to run at the programmed operation mode at the first section. When STF is off, the inverter stops running, and STR becomes the pause signal. When STR is on, the inverter pauses and continues to run at the section where the inverter paused when STR is off. For details, please refer to [P.100](#), [P.101~P.108](#), [P.111~P.118](#), [P.121~P.123](#) and [P.131~P.138](#).
- At the external mode, the manually operation circle mode is chosen when MPO is on. For details, please refer to [P.100](#), [P.101~P.108](#), [P.111~P.118](#), [P.121~P.123](#) and [P.131~P.138](#).
- Frequency set by pulse means: the inverter measure and calculate the ON times and OFF times in each PWM cycle, as its frequency directive.(the admissible PWM cycle is within 0.9ms~1100ms)

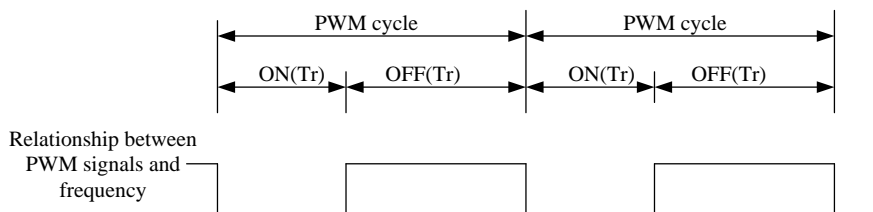

$$\text{Frequency (Hz)} = \frac{\text{ON times}}{\text{PWM cycle}} \times \text{Maximum frequency (Hz)}$$

This function is only for terminal. Near the lowest frequency or maximum frequency, output frequency precision which relative to the input signal will reduce; avoid the use of requiring a tight frequency control.

5.38 Multi-Function Control-Terminal Input Positive/Negative Logic (P.87)

P.87 “Multi-Function Control-Terminal Input Positive/Negative Logic”

- The function is bits-setting, if the bits shows 1, it means that the act of multi-function control terminal is negative logic; otherwise, it means that the act is positive logic.

Parameters	Factory Setting	Setting Range	Remarks
87	0	0~63	---

The definiton of each P.87 bits are as follows :

bit	2 ⁵	2 ⁴	2 ³	2 ²	2 ¹	2 ⁰
	RES	M2	M1	M0	STR	STF

For example : A three-wire control type needs the function of STOP to be kept open(negative logic). So if set P.80=31, take M0 terminal as three-wire control STOP function, and P.83=0, P.84=1, and take STF and STR terminals as default positive/negative logic function, the parameter of P.87 should be setted as follows:

bit	2 ⁵	2 ⁴	2 ³	2 ²	2 ¹	2 ⁰
	0	0	0	1	0	0

So $P.87 = 0 \times 25 + 0 \times 24 + 0 \times 23 + 1 \times 22 + 0 \times 21 + 0 \times 20 = 4$

Note: when multi-function control terminals select RES negative logic function, inverter will flicker and display Err (equal to perform external RESET function), which can be cancelled just by shorting-circuit SD and corresponding RES terminal, and inverter will work normally.

5.39 Multi-Function Output Terminal Positive/Negative Logic(P.88)

P.88 “Multi-function output terminal positive/negative logic(P.88) ”

- The function is bits-setting, if the bit is 1, it means that the act of multi-function output terminal is negative logic; otherwise, it means that the act is positive logic.

Parameters	Factory Setting	Setting Range	Remarks
88	0	0~3	---

The definition of each P.88 bits are as follows :

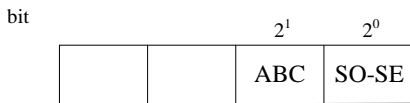

For example : P.85=0(inverter detects when running), if set positive logic output bit as 0, when inverter runs, multi-relay is on. when inverter stops, multi-relay is off ; otherwise, if set negative logic bit as 1, when inverter runs, multi-relay is off,and when the inverter stops, multi-relay is on.

5.40 Slip Compensation Coefficient (P.89) V/F

P.89 “Slip compensation coefficient”

- Setting this parameter appropriately enables the rotation speed of the motor under rated current to be closer to the set rotation speed.

Parameter	Factory Setting	Setting Range	Remarks	
			89	0
			10	Compensation value is 3% of the target frequency

5.41 The Inverter Model (P.90)

P.90 “The inverter model”

- P.90 is used to show the type and capacity of inverter, and the parameter can only be read.

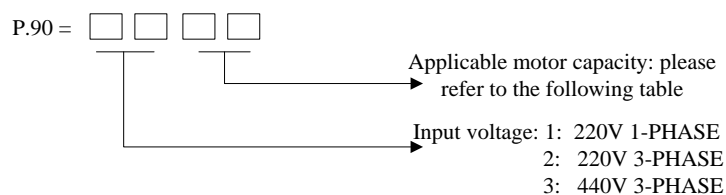

The applicable motor capacity is as following table:

Value (value of the two low-order bits of P.90)	capacity (kw)	Value (value of the two low-order bits of P.90)	capacity (kw)
2	0.4	3	0.75
4	1.5	5	2.2
6	3.7	7	5.5

5.42 Frequency Jump (P.91~P.96)

P.91~P.96 “Frequency jump”

- To avoid the system mechanical resonance frequency, three sets of jump frequencies are presented: P.91 and P.92 the first set, P.93 and P.94 the second set, and P.95 and P.96 the third set.

Parameter	Factory Setting	Setting Range	Remarks
91~96	9999	0~650Hz, 9999	9999: invalid

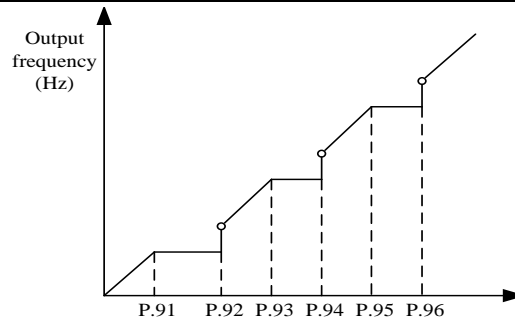

<Setting>

- For example: Suppose that P.91 = 45 and P.92 = 50
 - If the target frequency $\leq 45\text{Hz}$, the steady output frequency = the target frequency.
 - If $45\text{Hz} < \text{target frequency} \leq 50\text{Hz}$, the steady output frequency = 45Hz.
 - If $50\text{Hz} < \text{target frequency}$, the steady output frequency = the target frequency.

Note: 1. During acceleration/deceleration, the output frequency of the inverter will still pass through the jump frequency.
 2. If P.91=9999 or P.92=9999, the first set of the frequency jump is invalid.
 If P.93=9999 or P.94=9999, the second set of the frequency jump is invalid.
 If P.95=9999 or P.96=9999, the third set of the frequency jump is invalid.

5.43 The Second Frequency Source (P.97)

P.97 “The second frequency source”

- When multi-function control terminal selects the second frequency source setting enable which is valid, the frequency source is decided according to the P.97 setting value. And in this condition, it is impossible to change the operation mode.

Parameter	Factory Setting	Setting Range	Remarks	
			0	Frequency is given by operation panel PU
97	0	0~2	1	Frequency is given by communication
			2	Frequency is given by external terminal

Note: About multi-function control terminals function-selection and description, please refer to P.80 ~ P.84, P.86 About its corresponding wire arrangement, please refer to section 3.5.6

5.44 Programmed Operation Mode (P.100~P.108, P.111~P.118, P.121~P.123,

P.131~P.138)

P.100 “Minute/second selection”

P.101~P.108 “Runtime of each section”

P.111~P.118 “Acceleration/deceleration time of each section”

P.121 “Run direction in each section”

P.122 “Cycle selection”

P.123 “Acceleration/deceleration time setting selection”

P.131~P.138 “Frequency of each section”

Related parameters

P.7 “Acceleration time”
 P.8 “Deceleration time”
 P.21 “Acceleration/deceleration time increments”
 P.80~P.84, P.86
 “Multi-function terminals selection”

Parameter	Factory Setting	Setting Range	Remarks
100	1	0, 1	0 The running time minimum increment is 1 minute.
			1 The running time minimum increment is 1 second.
101~108	0s	0~6000s	---
111~118	0s	0~600s	When P.21=0
		0~6000s	When P.21=1
121	0	0~225	0: Cycle function invalid; 1~8: Run circularly
122	0	0~8	---
123	0	0, 1	---
131~138	0Hz	0~650Hz	---

<Setting>

1. Programmed operation mode

- The calculation methods of runtime and acceleration/deceleration time in each section are presented in the figure below:

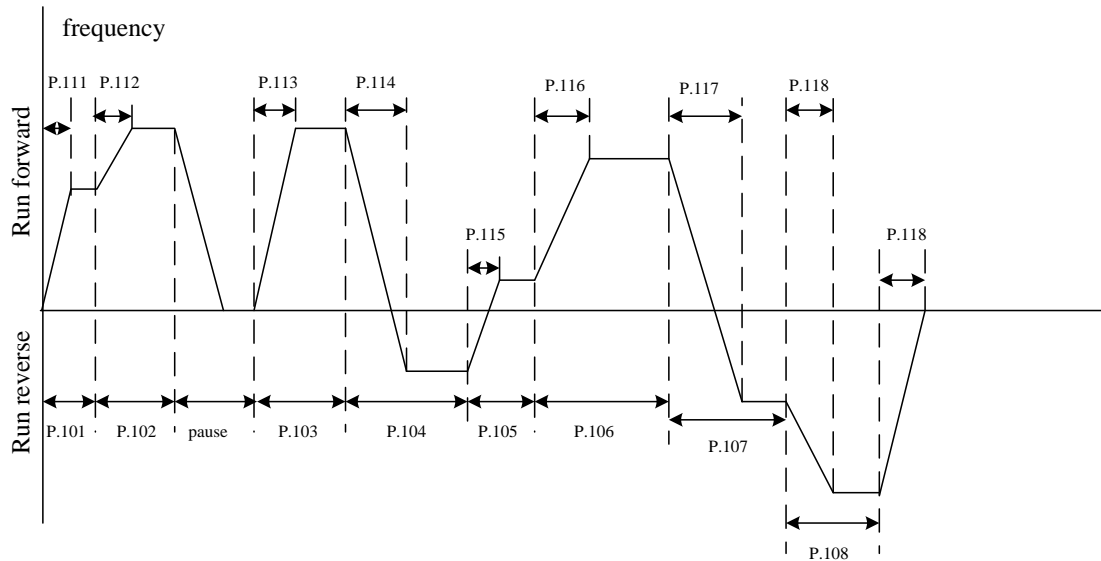

- The run direction is set in binary form (8-bit), then translated to decimal form and stored in P.121. '1' denotes run forward, and '0' denotes run reverse. The highest bit is the run direction of section 8, and the lowest bit is the direction of section 1.

For example: Suppose that section 1 for run forward, section 2 for run reverse, section 3 for run reverse, section 4 for run forward, section 5 for run reverse, section 6 for run forward, section 7 for run forward, and section 8 for run reverse, then the value in binary form is 01101001:

$$P.121 = 0 \times 2^7 + 1 \times 2^6 + 1 \times 2^5 + 0 \times 2^4 + 1 \times 2^3 + 0 \times 2^2 + 0 \times 2^1 + 1 \times 2^0 = 105$$

- When P.122=0, it won't run circularly.
- When the value of P.122 is 1~8, it is the initialization section of the cycle running.

For example: When P.122=3, the inverter will run circularly from the third section to the eighth section after it finishes the running from the first section to the eighth section.

When P.123=0, the acceleration time is determined by P.7, and the deceleration time is determined by P.8.

When P.123=1, the acceleration time and deceleration time are both determined by P.111~P.118.

2. Manually operation circle mode

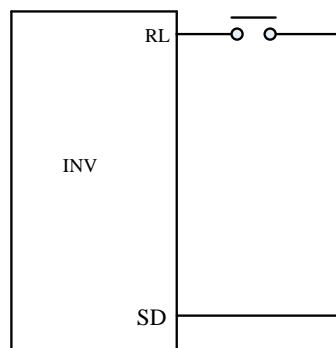

Wiring pattern for manually operation circle mode terminals

- Connect an impulse type switch between RL and SD.
- After turning on the power, set P.80=35 according to the terminal wiring. At this time, inverter is at standby.

• The mode of operation is presented in the figure below:

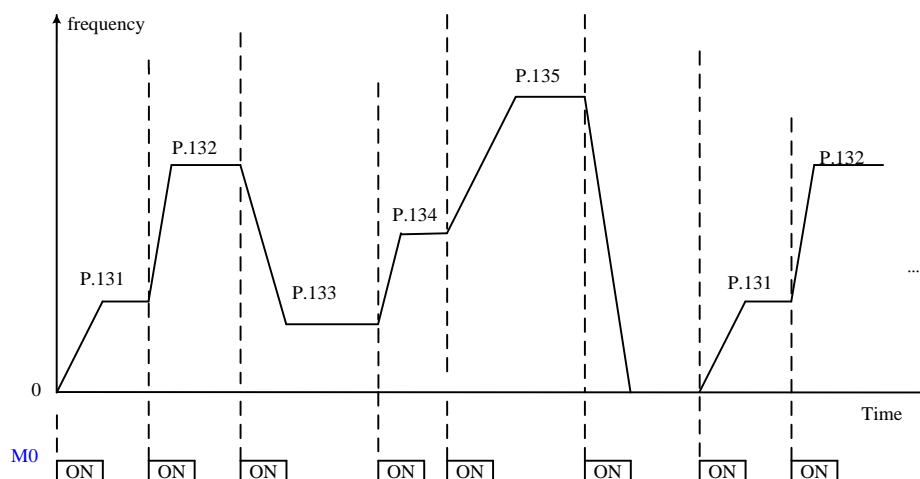

- Note: 1. The parameter P.100, P.101~P.108, P.111~P.118 and P.121~123 is only for programmed operation mode. In the manually operation circle mode, the acceleration time is determined by P.7, and the deceleration time is determined by P.8.
2. The inverter will run across most of the eight section, and the frequency is determined by P.131~P.138
3. When the frequency is set, the inverter will run standby in this section if any section is 0. It means that at the third mode the value of P.131 is not 0. Like the figure above, no matter what are the values of P.137 and P.138, the inverter will stop when pressing the sixth switch.
4. The manually operation circle mode has a single rotation direction. It has nothing to do with P.121 and STF or STR signal.

5.45 Operation Panel Monitoring Selection (P.110)

P.110 “Operation panel monitoring selection”

Parameter	Factory Setting	Setting Range	Remarks	
110	0	0~5	0	When the inverter starts, the operation panel enters the monitoring mode automatically, and the screen displays the output frequency.
			1	When the inverter starts, the screen of the operation panel displays the target frequency.
			2	When the inverter starts, the operation panel enters the monitoring mode automatically, and the screen displays the output frequency steady.
			3	When inverter starts, built-in keypad enters monitor mode automatically, screen displays current pressure and feedback pressure of the constant pressure system in percentage.
			4	When the inverter starts, the operation panel keeps the previous mode.
			5	When inverter starts, built-in keypad enters monitor mode automatically, screen displays current pressure and feedback pressure of the constant pressure system (Note 2 & 3)

Note: 1. Display current pressure and feedback pressure of the constant pressure system in percentage (00-06(P.110)="3"). The screen shows two sections. A decimal point is used to separate the boundaries, on the left is the target pressure and on the right is the feedback pressure of the constant pressure system in

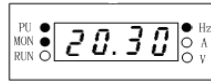

percentage. As shown in this figure : , “20” means the target pressure of the constant pressure system is 20%, the target value will be 20%*08-43(P.251); “30” means the feedback pressure of the constant pressure system is 30%, the feedback value will be 30%*08-43(P.251)。

2. Displays current pressure and feedback pressure of the constant pressure system (00-06(P.110)="5")

The screen shows two sections. A space is used to separate the boundaries, on the left is the target pressure and on the right is the feedback pressure of the constant pressure system.

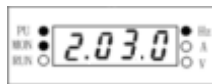

As shown in this figure: : “2.0” means the target pressure of the constant pressure system is 2.0, “3.0” means the feedback pressure of the constant pressure system is 3.0。 If PID function is turned on, the target frequency is derived from external keypad or built-in keypad (for example, PU mode or H1 mode). The target pressure can be selected directly from the target frequency setting in built-in keypad (this function is not supported in external keypad).

3.The function described in Note 2 is note supported in external keypad.

5.46 The selection of positive and reverse rotation dead time (P.119)

P.119 “The dead time of positive and reverse rotation”

- When the inverter is running and receive the reverse rotation command, the output frequency will decrease to 0 in the process of switching from the current rotation direction to the opposite rotation direction. The dead time of positive and reverse rotation is the waiting or holding time after the output frequency decreases to 0.

Parameter	Factory setting	Setting range	Remarks	
119	0	0~3000.0s	0	Without the function
			1~3000	The waiting or holding time after the output frequency decreases to 0 when the positive and reverse rotation is switching.

- The diagram is as follows:

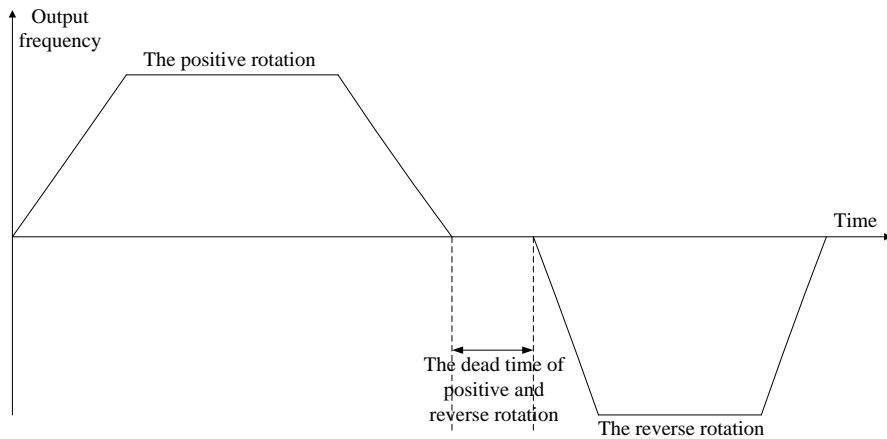

5.47 Zero-speed Function (P.151~P.152)

V/F

P.151 “Zero-speed control function selection”

P.152 “Voltage instruction at zero-speed control”

Related parameters

P.13 “Starting frequency”

- The user must set the value of P.13 zero when using this function.

Parameter	Factory Setting	Setting Range	Remarks	
151	0	0~1	0	There are no output at zero speed
			1	Control by DC (Note 1)
152	5%	0~30%	(Note 2)	

Note: 1.The output mode selected by the value of P.151: when P.151 is 0, there is no output; when P.151 is 1, the value of P152 is the voltage output dc voltage to keep the torque.

2. Suppose that P.152=6%, then the output voltage is $P.19 \times 6\%$ at zero-speed.

3. This function is only effective in V/F mode.Motor control mode to set see parameters p. 300

5.48 Over Torque Detection (P.155~P.156, P.260)

P.155 “Over torque detection level”

P.156 “Over torque detection time”

P.260“Over torque detection selection”

Related parameters

P.40 “Multi-function output terminal pattern”
P.85 “Function selection for multi-function relay”

- When the value of P.155 is not 0, the function of over torque detection is selected.
- When the output current is in the excess of the over torque detection level P.155 and the over torque detection time P.156, the screen of the inverter will display **OL2**.
- If the multi-function output terminal SO-SE (P.40) or the multi-function relay ABC (P.85) are set as over torque alarm (set the value to 12), the inverter will send out OL2 signal; If the multi-function output terminal SO-SE (P.40) or the multi-function relay ABC (P.85) are set as over load alarm (set the value to 3), only when P.260=1, will inverter send out OL signal. Please refer to P.40, P.85 for the details.

Parameter	Factory Setting	Setting Range	Remarks	
155	0%	0~200%	0	No detection for over torque
			0.1~200%	Detection for over torque
156	1s	0~60s	---	
260	1	0, 1	0	The OL2 alarm is not reported after the over torque detection, and the inverters continue to running.
			1	The OL2 alarm is reported after the over torque detection, and the inverters stop.

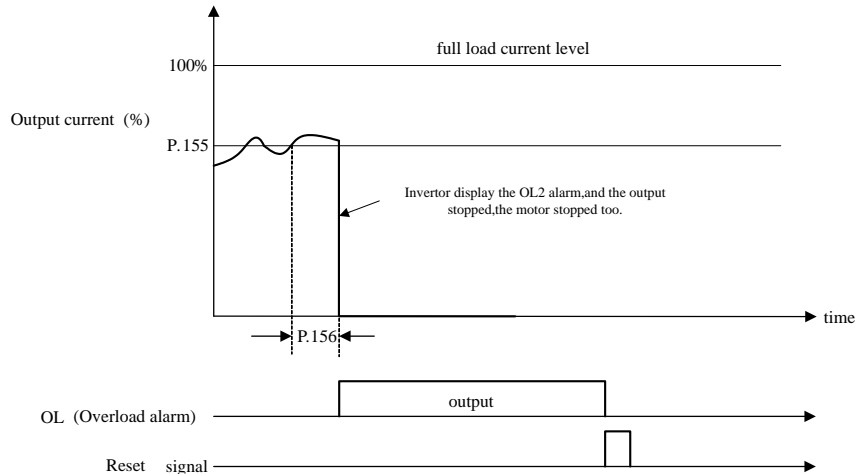

5.49 External Terminals Filter Adjusting Function (P.157)

P.157 “External terminals filter adjusting function”

Parameter	Factory Setting	Setting Range
157	4 ms	0~200ms

- P.157 selects response time to the signal of external terminal.

5.50 External Terminal Power Enable Function (P.158)

P.158 “External terminal power enable”

Parameter	Factory Setting	Setting Range
158	0	0~1

- If P.158=1, select the external terminal power enabling function. At this situation, if the multi-function terminal function is STF, STR, RUN or MPO and the opposite terminal is connected before the power is on, then the inverter will not run. The user should connect it to the terminal again and the inverter will start running. If P.158=1, the terminal is connected before the power is on, and if the power is on, the inverter will run immediately.

5.51 Energy-saving Control Function (P.159)

V/F

P.159 “Energy-saving control function”

Parameter	Factory Setting	Setting Range	Remarks
159	0	0	Normal running mode
		1	Energy-saving running mode

- At the energy-saving running mode, the inverter will control the output voltage automatically in order to reduce the output power losses when the inverter is running.

Note: 1. After selecting the energy-saving running mode, the deceleration time will be longer than the setting value probability. Also the regular torque load property will produce abnormal voltage easily, please set the deceleration time longer.

2. Big load purposes or frequent deceleration machine may cost more energy.

5.52 Multi-function Display (P.161)

P.161 “Multi-function display selection”

- The user can select what is shown at the monitoring output voltage mode by setting different values to P.161. The details are below:

Parameter	Factory Setting	Setting Range	Remarks	
161	0	0~13, 19~21	0	The current output voltage value.
			1	The current voltage between +/P and -/N.
			2	The accumulation rate of temperature increase of the inverter.
			3	The current target pressure of the constant pressure system.
			4	The current feedback pressure of the constant pressure system.
			5	The current operation frequency.
			6	The current electronic thermal accumulation rate.
			7	The value of the input signal across terminal 2-5 (V).
			8	The value of the input signal across terminal 4-5 (mA/V).
			9	The output power (kW)
			10	Reserved
			11	Operating condition $F r d$, $r E u$ and $\xi r \theta p$
			12	The current inverter module temperature.
			13	The current electronic thermal accumulation rate of motor.
			19	External terminal input state(about the sort of terminal, please refer to the table of the special monitor code in the communication part)
20	External terminal output state(about the sort of terminal, please refer to the table of the special monitor code in the communication part)			
21	The current valid carrier			

5.53 PID Control (P.170~P.183, P.223~P.225,P.251,P.253,P.254)

P.170 “PID function selection”

P.171 “PID feedback control method selection”

P.172 “PID proportion Gain”

P.173 “PID integration Gain”

P.174 “PID differential Gain”

P.175 “Abnormal deviation level”

P.176 “Exception duration time”

P.177 “Exception handling mode”

P.178 “Sleep detects deviation”

P.179 “Sleep detects duration time”

P.180 “Revival level”

P.181 “Outage level”

P.182 “Integral upper limit frequency”

P.183 “Deceleration step length with stable pressure”

P.223 “Analog feedback bias pressure”

P.224 “Analog feedback gain pressure”

P.225 “Panel command”

P.251 “PID maximum”

P.253 “Analog signal feedback loss detection time”

P.254 “Analog signal feedback loss action selection”

- During the operation of PID control, the frequency displayed on the screen is the output frequency of the inverter.
- The function of stall prevention operates according to the setting frequency before PID control. Please pay attention to the Gain setting during the process of PID Gain setting for it is possible that the output current can not be limited absolutely.
- Under PID control, the output frequency is also limited between the maximum frequency and the minimum frequency.
- Please refer to the instruction of P.60 about the input signal filter on terminal 4-5 and terminal 2-5.
- The sketch map of PID function is as follows:

$$T_s : \text{Sampling period} = 10\text{ms}$$

Parameter	Factory Setting	Setting Range	Remarks	
170	0	0, 1, 2	0	PID function non-selected
			1	The target value is determined by P.225. The feedback value is determined by the voltage of terminal 2-5.
			2	The target value is determined by P.225. The feedback value is determined by the voltage of terminal 4-5.
171	0	0,1	0	Negative feedback control. The calculation for the deviation is target value minors the feedback value. When an increase in the output frequency will increase the feedback value, select this setup.
			1	Positive and feedback control. The calculation for the deviation is feedback value minors the target value. When an increase in the

Parameter Description

Parameter	Factory Setting	Setting Range	Remarks	
			output frequency will decrease the feedback value, select this setup.	
172	20	1~100	This gain determines the proportion controller's impact on feedback deviation. The greater the gain, the faster the impact. Yet a gain that is too big will cause vibration.	
173	1s	0~100s	This parameter is use to set integral controller's integral time. When the integral gain is too big, the integral effect will be too weak to eliminate steady deviation. When the integral gain is too small, the system vibration frequency will increase, and therefore the system may be unstable.	
174	0ms	0~1000ms	This gain determines deviation controller's impact on the amount of change of the deviation. Appropriate deviation time can reduce the overshooting between the proportion controller and the integral controller. Yet when the deviation time is too large, system vibration may be induced.	
175	0	0~100%	---	
176	30s	0~600s	---	
177	0	0, 1,2	0	Free stop
			1	Decelerate and stop
			2	Continue to run when the alarm goes off
178	0	0~100%	---	
179	1s	0~255s	---	
180	90%	0~100%	---	
181	40Hz	0~120Hz	---	
182	50 Hz	0~120Hz	P.189=1	When the deviation value accumulated with the integral time, an upper limit for deviation accumulation should be set.
	60Hz		P.189=0	
183	0.5Hz	0~10Hz	When the feedback pressure satisfies the deviation value for stopping the machine and the set time (in seconds) for stopping the machine for detection is reached, the inverter will take the P.183 step to reduce the frequency.	
223	0%	0~100%	Revising the feedback signal to unify the signal range of inverter's feedback terminal and actual feedback, so that the inverter display in accordance with the feedback meter.	
224	100%			
225	20%	0~P.251, 9999	0~P.251	The target value is set by P.225.
			9999	When P170=1, 4-5 current/voltage set the target value; When P170=2, 2-5 voltage set the target value.
251	100.0	1.0~100.0	Set the range of PID target and feedback.	
253	0.0s	0.0~600.0s	Set the time of feedback disconnect detection, set to 0 to turn off the function.	
254	0	0~2	0	Alarm AErr and inverter stop freely
			1	Slow down to stop then alarm AErr
			2	Alarm AErr and continue operation

- The revising instruction of the analog feedback bias pressure and gain pressure:

1. The following system default value can be used without revising again:

The feedback of terminal 2-5		The feedback of terminal 4-5	
Revising voltage	Revising proportion	Revising current	Revising proportion
0.1V	P.223	4mA	P.223
5V	P.224	20mA	P.224

Note: The range of default setting is 0.1~5V. If there is a mismatch between the default setting range and the user's range, P.223 and P.224 can be set and P.170 must be set at last to unify the range.

Example: When the 0~7V feedback signal is given by terminal 2-5:

1). When P.171=0 (negative feedback control), $P.223 = 0.1 / 7 * 100.0 = 1.4$

$$P.224 = 5 / 7 * 100.0 = 71.4$$

2). When P.171=1 (positive feedback control), $P.223 = (7 - 0.1) / 7 * 100.0 = 98.6$

$$P.224 = (7 - 5) / 7 * 100.0 = 28.6$$

Example: When the 0~20mA feedback signal is given by terminal 4-5 (P.17=0, please make sure that the switch AVI/ACI is switched to ACI):

1). When P.171=0 (negative feedback control), $P.223 = 4 / 20 * 100.0 = 20.0$

$$P.224 = 20 / 20 * 100.0 = 100.0$$

2). When P.171=1 (positive feedback control), $P.223 = (20 - 4) / 20 * 100.0 = 80.0$

$$P.224 = (20 - 20) / 20 * 100.0 = 0$$

Note: If the feedback signal is given by the voltage of terminal 4-5, P.17 must be set firstly before above operation.

2. When the feedback signal need to be revised by the user:

Please adjust the feedback signal to a certain value and then calculate the proportion of the value to the feedback range, then write the proportion value into P.223.

After that, adjust the feedback signal to a new value and then calculate the proportion of the value to the feedback range, then write the proportion value into P.224.

Example: When the user's feedback range is 0~8V:

When the feedback signal is adjusted to 1V, $P.223 = (1 / 8) * 100.0 = 12.5$,

When the feedback signal is adjusted to 6V, $P.224 = (6 / 8) * 100.0 = 75.0$

Note: The actual feedback signal must be connected and the value of P.170 must be set before revising like this.

- The instruction for the target pressure given by external analog terminal:

1. When the target value is set by terminal 2-5

When P.73 = 0, the given range is 0~5V corresponding to 0~P.251;

When P.73 = 1, the given range is 0~10V corresponding to 0~ P.251.

2. When the target value is set by terminal 4-5

The given range is 4~20mA corresponding to 0~ P.251.

Example: Set P.170 = 1, P.171 = 0, P.225 = 9999.

It indicates that the PID target value is given by the current of terminal 4-5 (4~20mA).

If 8mA is given by the user, the corresponding given proportion is $(8-4) / (20-4) * P.251 = 25.0$.

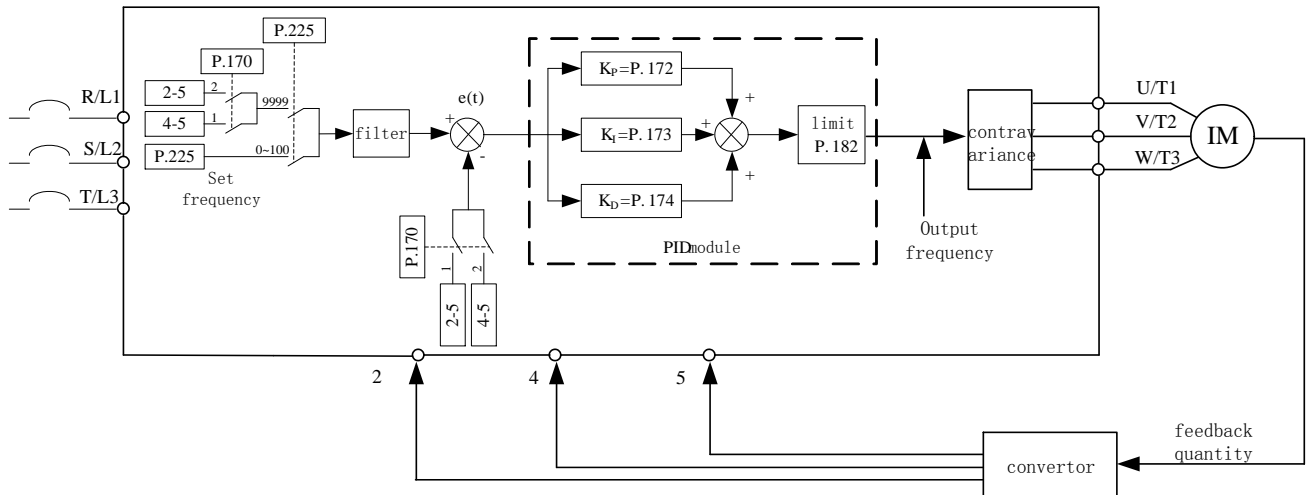

- When the feedback value is lower than the abnormal deviation level and continue exception duration time P.176, the PID is exceptional. This time the screen will display $P!0E$, and it will select freedom or brakes according to P.177.

For example: If P.175=60%, P.176=30s, P.177=0, and the feel-back value is lower than 60% of the target feel-back value and continue 30s, the screen will display $P!0E$ and freedom stop.

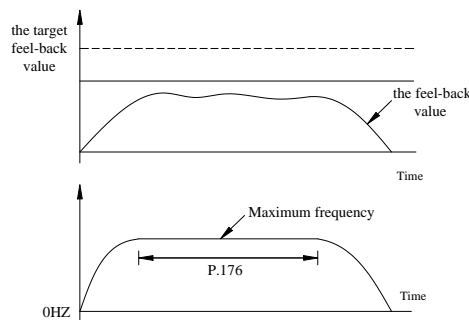

- If P.178=0, the values of P.179, P.180 and P.181 are invalid. If the value of P.178 is not 0, PID sleep function is selected. When the absolute value of feedback value subtract the target feedback is lower than the sleep detect deviation and continue sleep detect duration time P.179, the output frequency will be diminished gradually by the inverter. When the output frequency is lower than the outage level P.181, the inverter will be stopped. When the feedback value is lower than revival level P.180, the output frequency of inverter will select PID control function again.

For example: P.178=5%, P.179= 30s, P.180=90%, P.181=40Hz.

When the feedback value is larger than 95% of the target feedback value and is lower than 105% of the target feedback value for 10s continuously, the output frequency will be diminished gradually by the inverter. When the output frequency is lower than 40Hz, the inverter will be stopped. When the feedback value is lower than 90% of the target feedback value, the inverter will revival, and the output frequency of the inverter will select PID control function again.

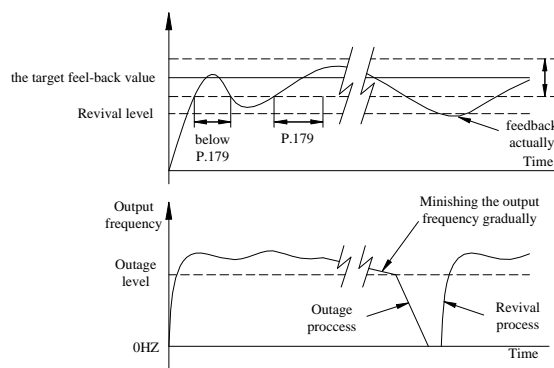

<Setting>

• PID gain easy setting:

(1)After changing target, response is slow

---Increase P-gain (KP =P.172)

response is quick but unstable

---Decrease P-gain (KP =P.172)

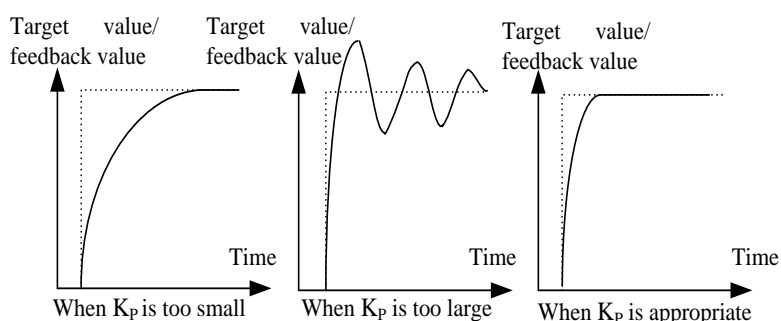

(2)Target and feedback

do not become equal

---Decrease Integration time (KI =P.173)

become equal after unstable vibration

---Increase Integration time (KI =P.173)

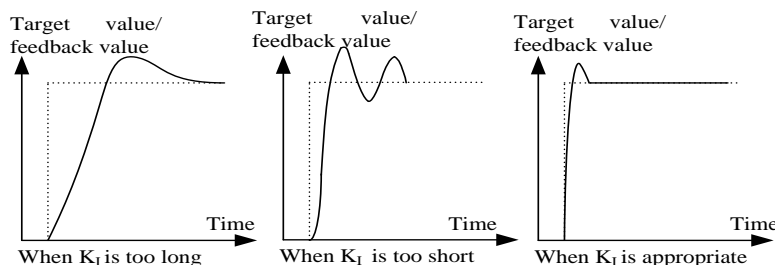

(3)Even after increasing KP, response is still slow

---Increase D-gain (KD =P.174)

It is still unstable

---Decrease D-gain (KD =P.174)

<Setting>

• PID pressure range

The setting of the PID target value can be %, bar, Kg, etc. Set 08-43 (P.251) if need the setting of the PID target value corresponds to the dimension of the actual system, generally set as feedback system sensor range.

For example: If the pressure sensor feedback range is 0~10V, the corresponding pressure range is 0~16.0bar, then 08-43 (P.251) set 16.0, and 08-03 (P.225)=8.0, then 00- 07 (P.161) = 3 (monitor target pressure) monitoring is: 8.0.

<Setting>

• PID analog signal feedback loss

- (1) Set 08-45 (P.253) to a non-zero value, when inverter is running, PID feedback disconnect exceeds the time set in 08-45 (P.253), inverter react as action set in 08-46 (P.254).
- (2) Set 08-45 (P.253) to 0, the feedback disconnection detection function is off.

Note: 1. When external 4-5 analog signal is given as pressure, please refer to the parameter P.17; Setting frequency range for external analog signal, please refer to parameter P.38, P.39, P.73.
 2. PID disconnection function is only suitable for 4-20mA terminal 3-5 signal type.

5.54 4-5 Terminal Disconnection Handling (P.184)

P.184 “4-5 terminal disconnection handling”

Parameter	Factory Setting	Setting Range	Remarks
184	0	0~3	---

<Setting>

- When P.184=0, this function is useless. If the terminal 4-5 is disconnected, the inverter will slow down to 0Hz. If it is connected to terminal 4-5 again, the inverter will accelerate to the corresponding frequency.
- When P.184=1, the keyboard panel should be shown “AErr” if the terminal 4-5 is disconnected, and the inverter will slow down to 0Hz. If it is connected to terminal 4-5 again, the alarm code will disappear and the inverter will be accelerated to the current corresponding to the frequency.
- When P.184=2, the keyboard panel should be shown “AErr” if the terminal 4-5 is disconnected. The inverter will be stopped immediately and need to be reset.
- When P.184=3, the keyboard panel should be shown “AErr” if terminal 4-5 is disconnected. The frequency before disconnecting from the inverter will operate continuously. Reconnect the line and the alarm will go off.

Note: When P.17=1 and 2, terminal 4-5 is set by voltage, and this function will be useless.

5.55 Proportion Linkage Function (P.185)

P.185 “Proportion linkage gain”

Parameter	Factory Setting	Setting Range	Remarks
185	0	0~100%	---

<Setting>

- By external analog signal input terminals on the function of setting frequency multiplier effects.
- If many inverters operation proportionally, take advantage of this function on the instructions of the master inverter to the salve inverter for fine-tuning more effective.
- After the setting frequency multiplier effects by the setting of P.185, then perform addition and subtraction operations.
- If P.185=0, the function is invalid.

For example: When the setting frequency is 50Hz, P.185=50% and external analog signal input for 0~10V.

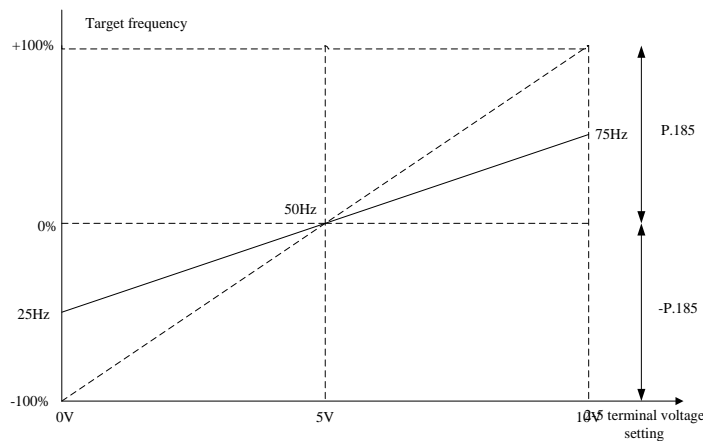

In the diagram:

At 0V, the target frequency can be calculated by this formula: $50\text{Hz} - (50\text{Hz} \times 50\%) = 25\text{Hz}$

At 5V, the target frequency can be calculated by this formula: $50\text{Hz} - (50\text{Hz} \times 0\%) = 50\text{Hz}$

At 10V, the target frequency can be calculated by this formula: $50\text{Hz} + (50\text{Hz} \times 50\%) = 75\text{Hz}$

Note: 1. Selecting the 4-5 external analog signal (voltage or current) input terminals, please refer to [P.17](#); the frequency range of the external analog signal, please refer to [P.38](#) and [P.39](#).
 2. Proportion linkage signal input, please refer to [P.240](#).

5.56 Firmware version (P.188)

P.188 “Firmware version”

- Parameters are readable only, not writable.

5.57 Factory Setting Function (P.189)

P.189 “Factory setting function”

Parameter	Factory Setting	Setting Range	Remarks	
189	1	0, 1	0	Apply to the 60Hz system
			1	Apply to the 50Hz system

- The user can select 50Hz or 60Hz frequency system as factory setting according to power supply frequency and motor default frequency. Correlation parameter directions are presented in the table below:

Parameter	Name	Setting Range	Minimum Setting Unit
<u>P.3</u>	Base frequency	0~650Hz	0.01Hz
<u>P.20</u>	Acceleration/deceleration reference frequency	1~650Hz	0.01Hz
<u>P.38</u>	The maximum output frequency (the target frequency is set by the input signal across terminal 2-5)	1~650Hz	0.01Hz
<u>P.39</u>	The maximum output frequency (the target frequency is set by the input signal across terminal 4-5)	1~650Hz	0.01Hz
<u>P.55</u>	Frequency display reference	0~650Hz	0.01Hz
<u>P.66</u>	Stall prevention operation reduction starting frequency	0~650Hz	0.01Hz
<u>P.182</u>	Integral upper limit frequency	0~120Hz	0.01Hz
<u>P.195</u>	Frequency corresponds to the maximum input voltage of the terminal 2-5	0~650Hz	0.01Hz
<u>P.197</u>	Frequency corresponds to the maximum input voltage/current across the terminal 4-5	0~650Hz	0.01Hz
<u>P.305</u>	Motor rated frequency	0~650Hz	0.01Hz

Note: 1. If the users have some problems from adjusting the factory setting witch in the table above, deceleration time, output voltage, voltage signal and setting frequency may be affected.

2. If the users need to adjust the factory setting to 60Hz, take the following steps:

- (1) Sett P.189=0;
- (2) Set P.998 to resume the factory setting (This time, the factory setting of interrelated parameter is 60Hz and P.189=0). Please refer to P.998 in Section 4.

3. If the users need to resume the 50Hz system, set P.189=1 and implement Step 2 in Note 2 (the factory setting of P.189 is 1).

5.58 Input Signal across Terminal 2-5 (P.192~P.195)

P.192 “2-5 terminal minimum input voltage”

P.193 “2-5 terminal maximum input voltage”

P.194 “Frequency corresponds to the minimum input voltage of terminal 2-5”

P.195 “Frequency corresponds to the maximum input voltage of terminal 2-5”

Parameter	Factory Setting	Setting Range	Remarks
192	0	0~10	---
193	0	0~10	---
194	0Hz	0~60Hz	---
195	50Hz	0~650Hz	P.189=1
	60Hz		P.189=0

<Setting>

• Emendation steps:

1. Make sure that the voltage signal is correctly inputted.
2. Assume that the input voltage equals Value A and the expected output frequency is 20Hz, then adjust the signal to Value A, and write 20 into P.194. Also Value A will be written into P.192.
3. Assume that the input voltage equals Value B and the expected output frequency is 60Hz, then adjust the signal to Value B, and write 60 into P.195, also Value B will be written into P.193.

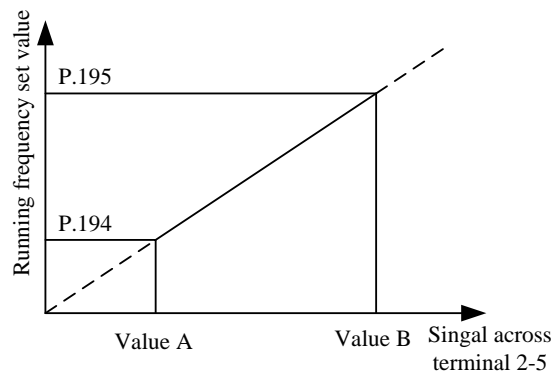

Note: 1. The equation for the above curve is:

$$\frac{\text{Running frequency}-\text{P.194}}{\text{Voltage value}-\text{Value A}} = \frac{\text{P.195}-\text{P.194}}{\text{Value B}-\text{Value A}}$$

2. If the user can not provide the actual stability of the signal input, the user can set up the parameters P.192 and P.193 manually. The value of P.192 corresponds to the frequency of the P.194 set. The value of P.193 corresponds to the frequency of the P.195 set. When setting up the parameters manually, verify the range of P.194 and P.195, and then adjust the voltage value of P.192 and P.193.
3. After resetting any of P.192~P.195, the curve of P.38 will be invalid.

5.59 Input Signal across Terminal 4-5 (P.196~P.199)

P.196 “Frequency corresponds to the minimum input current/voltage across terminal 4-5”

P.197 “Frequency corresponds to the maximum input current/voltage across terminal 4-5”

P.198 “Minimum input current/voltage across terminal 4-5”

P.199 “Maximum input current/voltage across terminal 4-5”

Parameter	Factory Setting	Setting Range	Remarks
196	0	0~60Hz	---
197	50Hz	0~650Hz	P.189=1
	60Hz		P.189=0
198	0	0~20	---
199	0	0~20	---

<Setting>

• Emendation steps:

1. Make sure that the current signal is correctly inputted.
2. Assume that the input current equals Value A and the expected output frequency is 20Hz. Adjust the signal to Value A, and write 20 into P.196. Also, Value A will be written into P.198.
3. Assume that the input current equals to Value B, and the expected output frequency is 60Hz. Adjust the signal to Value B, and write 60 into P.197. Also, Value B will be written into P.199.

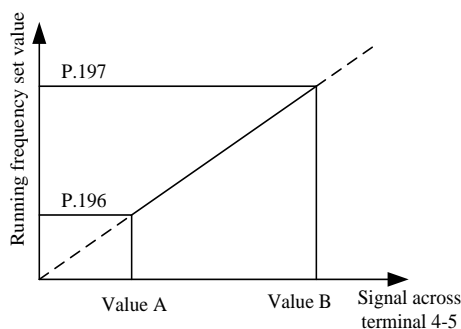

Note: 1. The equation for the above figure is:

$$\frac{\text{Running frequency}-\text{P.196}}{\text{Current value}-\text{Value A}} = \frac{\text{P.197}-\text{P.196}}{\text{Value B}-\text{Value A}}$$

2. If the user can not provide the actual stability of the signal input, parameters P.198 and P.199 can be set up manually. The value of P.198 corresponds to the frequency of the P.196 set. The value of P.199 corresponds to the frequency of the P.197 set. When setting up the parameters manually, verify the range of P.196 and P.197, and then adjust the voltage values of P.198 and P.199.
3. After any resetting of P.196~P.197, the curve of P.39 becomes invalid.
4. For selecting the input signal across terminal 4-5, please refer to P.17.

5.60 The Paver Function (P.226~P.228)

P.226 “The paver function selection”

P.227 “The limit time of positive rotation”

P.228 “The limit time of reverse rotation”

Parameter	Factory Setting	Setting Range	Remarks
226	0	0, 1	The paver function is valid when 1 is set and invalid when 0 is set.
227	0	0~3600s	The inverter will decelerate and stop when the inverter keep positive running for more than the setting time of P.227. The function is invalid when 0 is set.
228	0	0~3600s	The inverter will decelerate and stop when the inverter keep reverse running for more than the setting time of P.228. The function is invalid when 0 is set.

<Setting>

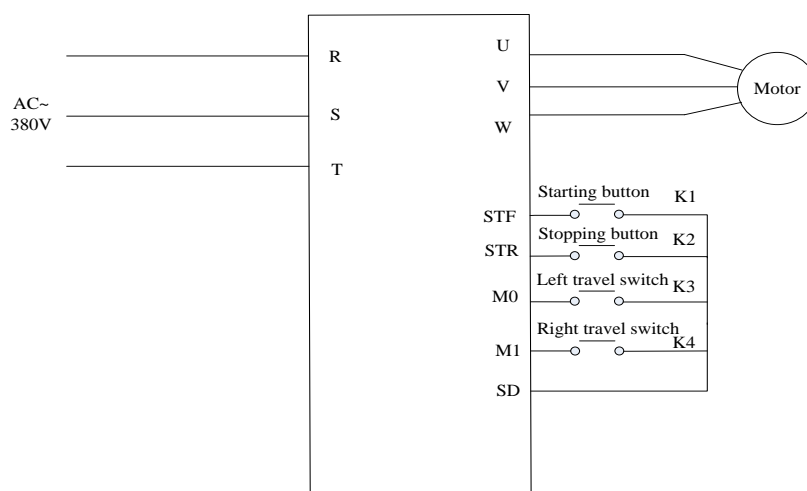

The system wiring diagram

- Please wire as above diagram. Connect travel switch between M0 and SD, and between M1 and SD. Connect pulse switch between STF and SD, and STR and SD.
- After the inverter is powered on and P.998 is performed, the paver system is selected when P.226 is set to 1. The set values of multi-function terminals are all the factory default values which need not to be changed. If the target frequency is given by the external terminals, the closing of the terminal M0 and M1 will affect the target frequency, so please set the value of P.5 and P.6 as the same as the target frequency value.
- When K3 and K4 are all open, after pressing K1 it will forward rotate until K3 closes in a minute, then contrarotate until K4 closes in a minute, and then forward rotate again to reciprocate. If K2 is pressed, the system will stop.
- When K3 (or K4) is closed, after pressing K1 it will contrarotate (or forward rotate) until K4 (or K3) closes in a minute, and then forward rotate (or contrarotate). If K2 is pressed, the system will stop.

- To avoid a series of dangerous conditions caused by the broken travel switch, the one-way running time which is the limit time of positive and reverse rotation. The two travel switches are not allowed to close in the meantime, or the system will stop.

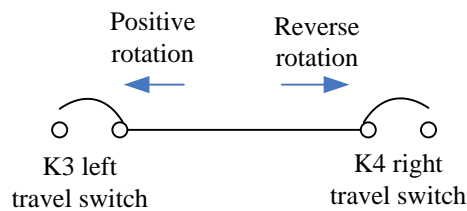

The diagram of operation flow

5.61 Backlash Compensation and Acceleration/Deceleration Interrupted for Waiting Function (P.229~P.233) V/F

P.229 “Backlash compensation and acceleration/deceleration interrupted for waiting function selection”

P.230 “The acceleration interrupt frequency”

P.231 “The acceleration interrupt time”

P.232 “The deceleration interrupt frequency”

P.233 “The deceleration interrupt time”

Parameter	Factory Setting	Setting Range	Remarks	
229	0	0~2	0	The function is invalid.
			1	The backlash compensation function is selected.
			2	The acceleration/deceleration interrupted for waiting function is selected
230	1Hz	0~650Hz	---	
231	0.5s	0~360s	---	
232	1Hz	0~650Hz	---	
233	0.5s	0~360s	---	

• Backlash countermeasures

What is the Backlash compensation?

Reduction gears have an engagement gap and have a dead zone between forward rotation and reverse rotation. This dead zone is called backlash, and this gap disables the mechanical system from following motor rotation.

More specifically, a motor shaft develops excessive torque when the direction of rotation changes or when constant-speed operation shifts to deceleration, resulting in a sudden motor current increase or regenerative status.

To avoid backlash, temporarily stop the acceleration/deceleration. Set the acceleration/deceleration stopping frequency and time in P.229 to P.233.

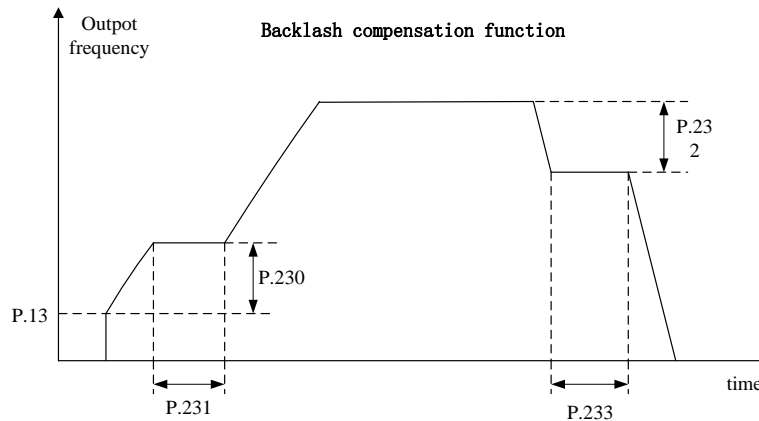

Note: When setting up backlash compensation, acceleration /deceleration time only in part time longer.

●Acceleration/deceleration interrupted for waiting function

If P.229=2 and start the acceleration/deceleration interrupted for waiting function, when accelerate to the frequency set by P.230, it will keep the frequency for some time set by P.231, and then accelerate again to the target frequency; when decelerate to the frequency set by P.232, it will keep the frequency for some time set by P.233, and then decelerate again to the target frequency.

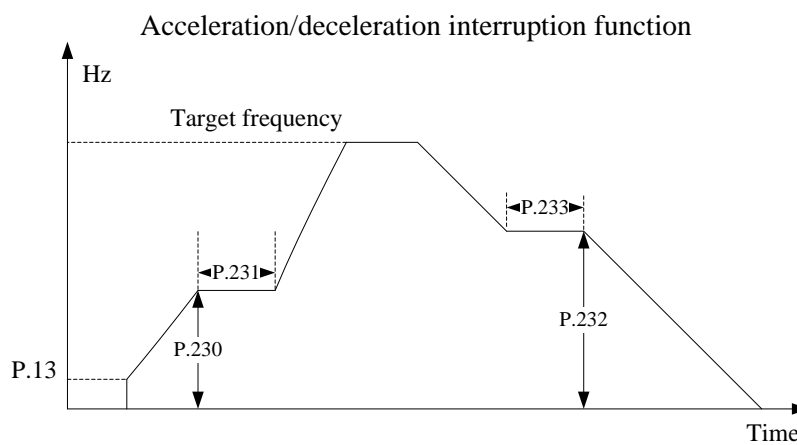

5.62 Triangular Wave Function (P.234~P.239) V/F

P.234 “Triangular wave function selection”

P.235 “Maximum amplitude”

P.236 “Amplitude compensation for deceleration”

P.237 “Amplitude compensation for acceleration”

P.238 “Amplitude acceleration time”

P.239 “Amplitude deceleration time”

Parameter	Factory Setting	Setting Range	Remarks
234	0	0~2	---
235	10%	0~25%	---
236	10%	0~50%	---
237	10%	0~50%	---
238	10s	0~360s/0~3600s	If P.21=0, the minimum increments of P.238 and P.239 is 0.01 seconds.
239	10s	0~360s/0~3600s	If P.21=1, the minimum increments of P.238 and P.239 is 0.1 seconds.

<Setting>

- The triangular wave function is effective if the value of parameter P.234 is 1 and the signal is on. Please set 36 to any parameter: P.80~P.84, P.86, corresponding to the external terminal assigned for TRI signal.
- If the value of the parameter is 2, it means the triangular wave function is effective all the time.

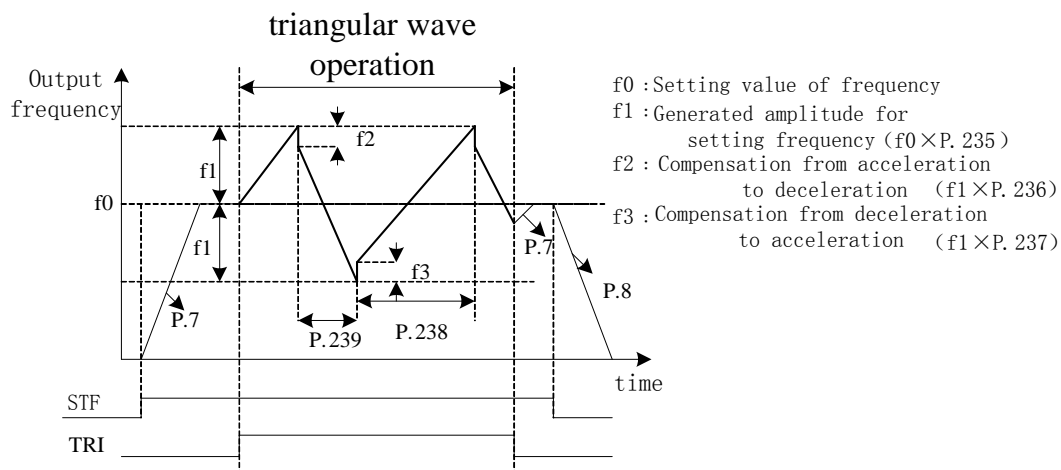

Note: 1. The output frequency will be limited by the maximum frequency and minimum frequency when the triangular wave function is effective.

2. If the amplitude compensation (P.236 or P.237) is too larger, over-voltage trip and stall prevention operation will run automatically. Thus the inverter can not run according to the triangular wave function.

5.63 Auxiliary Frequency Function (P.240)

P.240 “Auxiliary frequency function selection”

Parameter	Factory Setting	Setting Range	Remarks
240	0	0~6	---

<Setting>

- When the value of P.240 is 0, auxiliary frequency function is not selected.
- When the value of P.240 is 1, operation frequency = basic frequency + auxiliary frequency (2-5),
- When the value of P.240 is 2, operation frequency = basic frequency + auxiliary frequency (4-5),
- When the value of P.240 is 3, operation frequency = basic frequency - auxiliary frequency (2-5),
- When the value of P.240 is 4, operation frequency = basic frequency - auxiliary frequency (4-5),
- When the value of P.240 is 5, 2-5 terminals given as a proportion linkage signal,
- When the value of P.240 is 6, 4-5 terminals given as a proportion linkage signal.
- When the operation frequency is less than P.2, the operation frequency should be equal to P.2. When the operation frequency is more than P.1, the operation frequency should equal to P.1.

Note: 1. Basic frequency is set by the target frequency reference source operation panel, communications, analog signal (2-5/4-5) input or combination of multi-speed gears.
 2. The proportion linkage function please refer to P.185.
 3. Selecting the 4-5 external analog signal (voltage or current) input terminals, please refer to P.17; the frequency range of the external analog signal, please refer to P.38 and P.39.

5.64 DC Injection Brake Function before Starting (P.242~P.244) V/F

P.242 “DC injection brake function before starting selection”

P.243 “DC injection brake time before starting”

P.244 “DC injection brake voltage before starting”

Parameter	Factory Setting	Setting Range	Remarks
242	0	0~1	---
243	0.5s	0~60s	---
244	4%	0~30%	---

<Setting>

- If P.242=0, the DC injection brake function before starting is not selected. If P.242=1, the DC brake injection function before starting is selected. When the output frequency reached the starting frequency (P.13), a DC voltage (P.244) will be injected into the motor windings by the inverter, which is used to lock the motor rotor. The DC brake operation will last for a period (the set value of P.243) before the motor start.

As shown as follows:

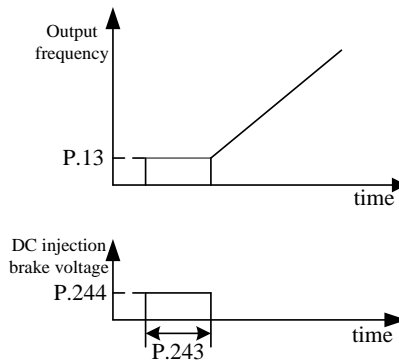

5.65 Options for Stopping the Cooling Fan (P.245)

P.245 “Cooling fan operation selection”

Parameter	Factory setting	Setting range	Remarks
245	1	0~3	---

<Setting>

- When P.245=0, the fan will be turned on by the RUN signal. The fan will be turned off 30 seconds after the inverter stops.
- When P.245=1, turning on the power will turn on the fan. When the power is turned off, the fan will be off, too.
- When P.245=2, the fan will be turned on if the temperature of the heat sink is higher than 60°C and will be turned off if the temperature of the heat sink is lower than 40°C. When the inverter stops, the fan will be off, too.
- When P.245=3, the fan will be turned on when the temperature of the heat sink is higher than 60°C. and will be turned off when the temperature of the heat sink is lower than 40°C.

5.66 Commercial Power Supply Frequency Operation Function

(P.247~P.250) V/F

P.247 “MC switchover interlock time”

P.248 “Start waiting time”

P.249 “Automatic switchover frequency from inverter to commercial power supply frequency”

P.250 “Automatic switchover frequency range from commercial power supply to inverter”

Parameter	Factory setting	Setting range	Remarks
247	1s	0.1~100s	---
248	0.5 s	0.1~100 s	---
249	9999	0~60Hz, 9999	---
250	9999	0~10Hz, 9999	---

<Setting>

- P.249 is used to switch the frequency from inverter operation to commercial power supply operation. Between starting and P.249 inverter operation, an output frequency greater than P.249 will automatically change the inverter operation to commercial power supply operation. When P.249 is set to 9999, there is no automatic switchover.
- When P.250≠9999, automatic switchover is valid during the operation (P.249≠9999). After the inverter operation is switched bypass operation, if the frequency command is lower than (P.249–P.250), the operation will be switched to inverter operation and run by the frequency of the frequency command. Inverter activation when the inverter start command (STF/STR) is turned off, the operation is also switched to the inverter operation.
- When P.250=9999, it is valid during automatic switchover operation (P.249≠9999). When the inverter start command (STF/STR) is turned off after the operation is changed from inverter operation to commercial power supply operation, the operation will be changed to the inverter operation and the motor will decelerate until it stops.

Examples for the commercial power supply frequency switchover function:

The following diagram is the representative wiring diagram for altering the commercial power-supply operation. P.80 = 37, P.81 = 38, P.40 = 10, P.85 = 9.

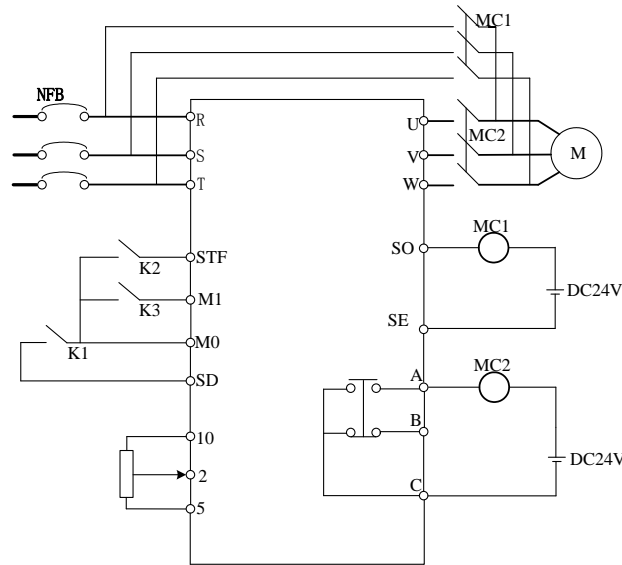

Please pay attention to the capacity of the output terminals. The terminals are used according to the different settings for P.40 and P.85 (output terminal function selection). When the output terminal function selects 10, connect the relay driving the commercial power-supply operation. When the output terminal function selects 9, connect the relay driving the inverter operation. When the external input terminal function selects 37, switch the inverter to commercial power-supply operation. When the external input terminal function selects 38, manually switch the signal CS.

Warning:

1. MC1 and MC2 must be mechanically interlocked; the running direction of the inverter operation and the commercial power supply operation should be consistent.
2. Use the commercial power operation switchover function under the external operation mode.
3. STF/STR is effective when the CS signal is ON.

Here are some typical sequence diagrams for the switchover of the commercial power supply frequency:

1. Action sequence without the automatic switchover sequence (P.249=9999).

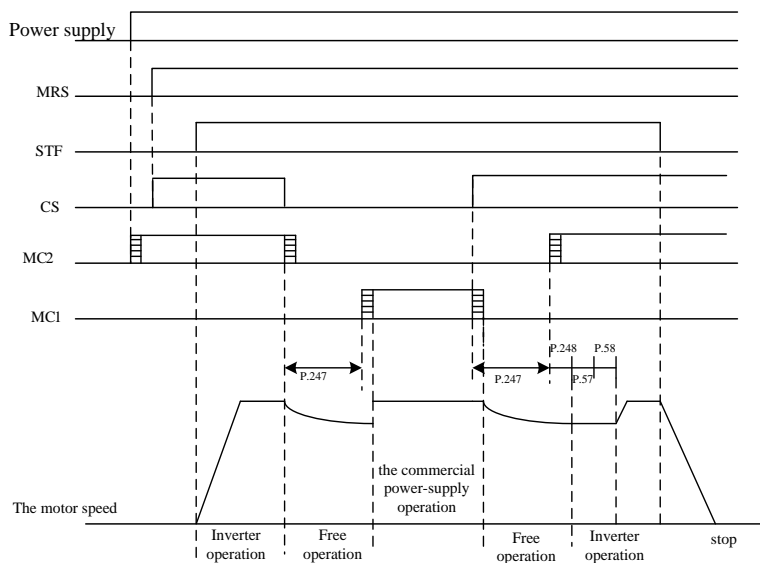

2. Action sequences with the automatic switchover sequence (P.249≠9999, P.250=9999).

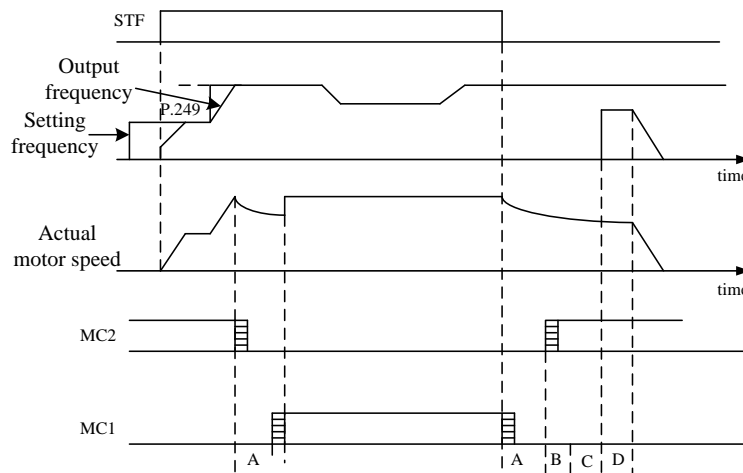

3. Action sequences with the automatic switchover sequence series (P.249≠9999, P.250 ≠ 9999).

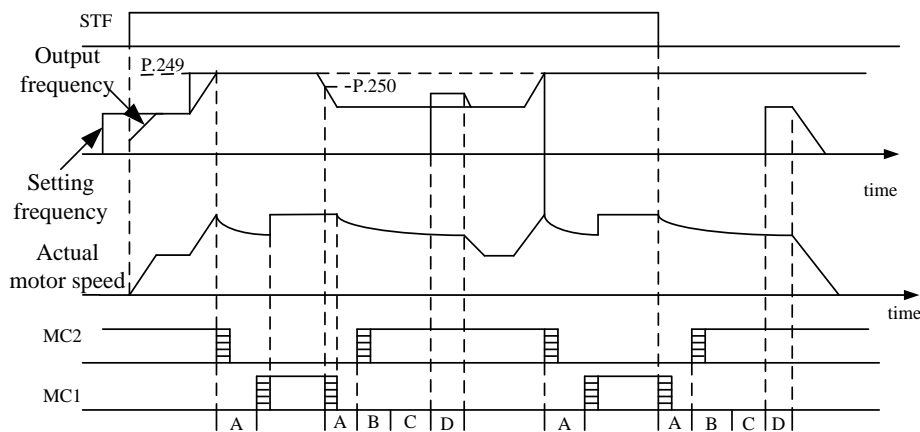

During the automatic switchover, A: P.247 MC Switchover interlocking time; B: P.248 starting waiting time; C: P.57 restarting free operation time; D: P.58 restarting elevating time.

Note: 1. When the motor runs at 50Hz (or 60Hz), the commercial power supply will offer a more efficient operation than the inverter will. Moreover, during the inverter maintenance/inspection period, the commercial power supply circuit should be installed to prevent the motor from being stopped for too long.

2. To prevent the inverter from setting off the over-current alarm when changing between the inverter operation and the commercial power supply operation, the interlock measure has to be taken. Once the motor stops, it will be activated via the inverter. Switchover and interlock can be carried out through the inverter and a complicated commercial power supply if commercial power supply switchover sequence function that can send out the signal for electromagnetic contactor actions is used.

5.67 Maintenance Alarm Function (P.261)

P.261 “Maintenance Alarm Time”

- When Multi-function output terminal (P.40, P.85) equals 18, maintenance alarm is detecting. It means that when the inverter runs for the days that reach the parameter P.261 set value of maintenance alarm time, the multi-function terminal SO-SE or multi-function relay will send out signal.

Parameter	Factory setting	Setting range	Remarks	
P.261	0	0~9998 day	0	No maintenance alarm
			1~9998	Used to set time when maintenance alarm sends out signal

5.68 Voltage stall action level (P.268)

P.268 “Voltage stall action level”

Parameter	Default	Setting Range	Content
P.268	380V	155~410V	220V model
	760V	310~820V	440V model

<Setting>

- When the inverter's DC bus voltage is higher than the setting of 10-46 (P.268), the inverter is in voltage stall state.

5.69 Vibration Inhibition Factor (P.286)

P.286 “High frequency vibration inhibition factor”

Parameter	Factory setting	Setting range	Remarks
P.286	0	0~15	---

<Setting>

1. If motor vibration is generated at higher frequency, adjust the set value of P.286. Gradually increase the set value by the unit of 1.
2. For the actual application, use the vibration-generating frequency that is lower or higher than half of the motor rated frequency to determine whether the occurred vibration is a low-frequency vibration or a high-frequency vibration. That is, if the rated frequency on the name plate of the motor is 50Hz and the vibration-generating frequency is higher than 25Hz, then this is a high-frequency vibration.

Note: 1. When the motor load is light, current flow may happen at certain specific operation frequency. This situation may cause the motor to vibrate slightly. The user can neglect it if this trivial vibration has no impact on the application.

2. If the current flow is serious (generating vibration), it may cause serious motor vibration or even inverter over-current. The user can try to adjust the vibration inhibition factor to improve the situation.

5.70 Short Circuit Protection Function (P.287)

P.287 “Short circuit protection function selection”

Parameter	Factory setting	Setting range	Remarks
287	1	0~1	---

<Setting>

- Set P.287 to 0 to cancel the output end short-circuits protection function.
- When P.287 is set to 1, if the output end is short, the operation panel will display the “SCP” abnormal alarm and the inverter will stop the output.

5.71 Alarm History Parameters (P.288~P.291)

P.288 “Alarm code display option”

P.289 “Alarm code”

P.290 “The latest alarm status selection”

P.291 “The latest alarm message”

- This paragraph provides the users with parameter-related information on alarm codes for frequency, current, voltage, as well as the 12 alarm codes mentioned earlier. If P.996 operation is executed, the abnormal codes and the status messages for the occurred alarms recorded by this set of parameters will be all cleared.

Parameter	Factory setting	Setting range	Remarks
288	0	0~12	The value of P.288, 1~12, corresponds to the abnormal codes of P.289’s alarm E1~E12.
289	0	---	
290	0	0~6	When P.290=1, P.291 corresponds to the frequency when the alarm goes off. When P.290=2, P.291 corresponds to the current when the alarm goes off. When P.290=3, P.291 corresponds to the output voltage when the alarm goes off.
291	0	---	When P.290=4, P.291 corresponds to the accumulation rate of temperature increase when the

Parameter Description

			<p>alarm goes off.</p> <p>When P.290=5, P.291 corresponds to the (+/P)-(-N) voltage when the alarm goes off.</p> <p>When P.290=6, P.291 corresponds to the running time of inverter(P.293*1440+P.292) when the current alarm occurs.</p>
--	--	--	--

If both P.288 and P.290 are 0, P.289 and P.291 will be displayed as 0. Both P.289 and P.291 are read-only parameters.

Abnormal code corresponded alarm condition:

Abnormal Number	Alarm Code	Abnormal Number	Alarm Code	Abnormal Number	Alarm Code	Abnormal Number	Alarm Code
00 (H00)	No alarm	33 (H21)	OV2	64 (H40)	EEP	160 (HA0)	OPT
16 (H10)	OC1	34 (H22)	OV3	66 (H42)	PIDE	179 (HB3)	SCP
17 (H11)	OC2	35 (H23)	OV0	97 (H61)	OLS	192 (HC0)	CPU
18 (H12)	OC3	48 (H30)	THT	98 (H62)	OL2	193 (HC1)	CPR
19 (H13)	OC0	49 (H31)	THN	129 (H81)	AErr		
32 (H20)	OV1	50 (H32)	NTC	144 (H90)	OHT		

5.72 Accumulative Motor Operation Time Function (P.292, P.293)

P.292 “Accumulative motor operation time (minutes)”

P.293 “Accumulative motor operation time (days)”

Parameter	Factory Setting	Setting Range	Remarks
292	0min	0~1439min	---
293	0day	0~9998day	---

<Setting>

- P.292 means the minutes of accumulative motor operation, execute P.998, shut off the power, and the updated value cannot change the value of P.292. The only way to clear the accumulation of time is to set P.292 to 0.
- P.293 is about the accumulative motor operation time in days. The updated value cannot be modified by executing P.998 or power shutdown. To clear the accumulated time, make P.293=0.

5.73 Password Protection Function (P.294 and P.295)

P.294 “Decryption parameter”

P.295 “Password setup”

Parameter	Factory setting	Setting range	Remarks
294	0	0~9998	---
295	0	2~9998	---

<Setting>

- P.294 is the parameter that provides the decrypt function. P.294 will be zero if the decryption is successful. Use P.295 to set the password. Enter the initial password into P.294 to decrypt the parameter password and to modify or to set up various parameters.
- P.295 is the parameter for setting up the password. The password has to be greater than 1. Once the password setup is completed, P.295 will display 1. After deleting the password, P.295 will display 0. Once the password is set, no parameter can be modified, except P.294. P.998 and power shutdown have no effect on the password. The parameters can be revised only after the decryption.

Note: If password is forgotten, enter the same incorrect password three times in 00-04(P.294), and the interval between two consecutive times is not more than 10s. The password can be cleared and the user parameters will be automatically restored to default.

5.74 Motor Control Mode (P.300 and P.301)

P.300 “Motor control mode selection”

P.301 “Motor parameter auto-tuning function selection”

Parameter	Factory setting	Setting range	Remarks	
300	0	0~2	0	V/F control
			1	---
			2	General flux vector control
301	0	0~3	0	No motor parameter auto-tuning function
			1	Motor parameter auto-tuning measuring the running motor
			2	Motor parameter auto-tuning measuring the stopped motor
			3	Online auto measurement function

<Setting>

- When P.300=0, no motor parameter auto-tuning function is required for normal V/F curve operation.
- For general magnetic vector control, please set P.300 to 2. The frequency will be altered due to elevated voltage and increased compensatory motor load.
- For executing the motor parameter auto-tuning function, set P.301 to 1 or 2 and press the forward rotation or the reverse rotation key. During the measuring process, the operation panel will flicker and display “TUN”. If the measurement is success, the operation panel will display “TEND” and flicker. If the measurement fails, the operation panel will flicker “FAL”. Press down  for 1s, return to normal display.

- Procedures for motor parameter auto-tuning are presented below:

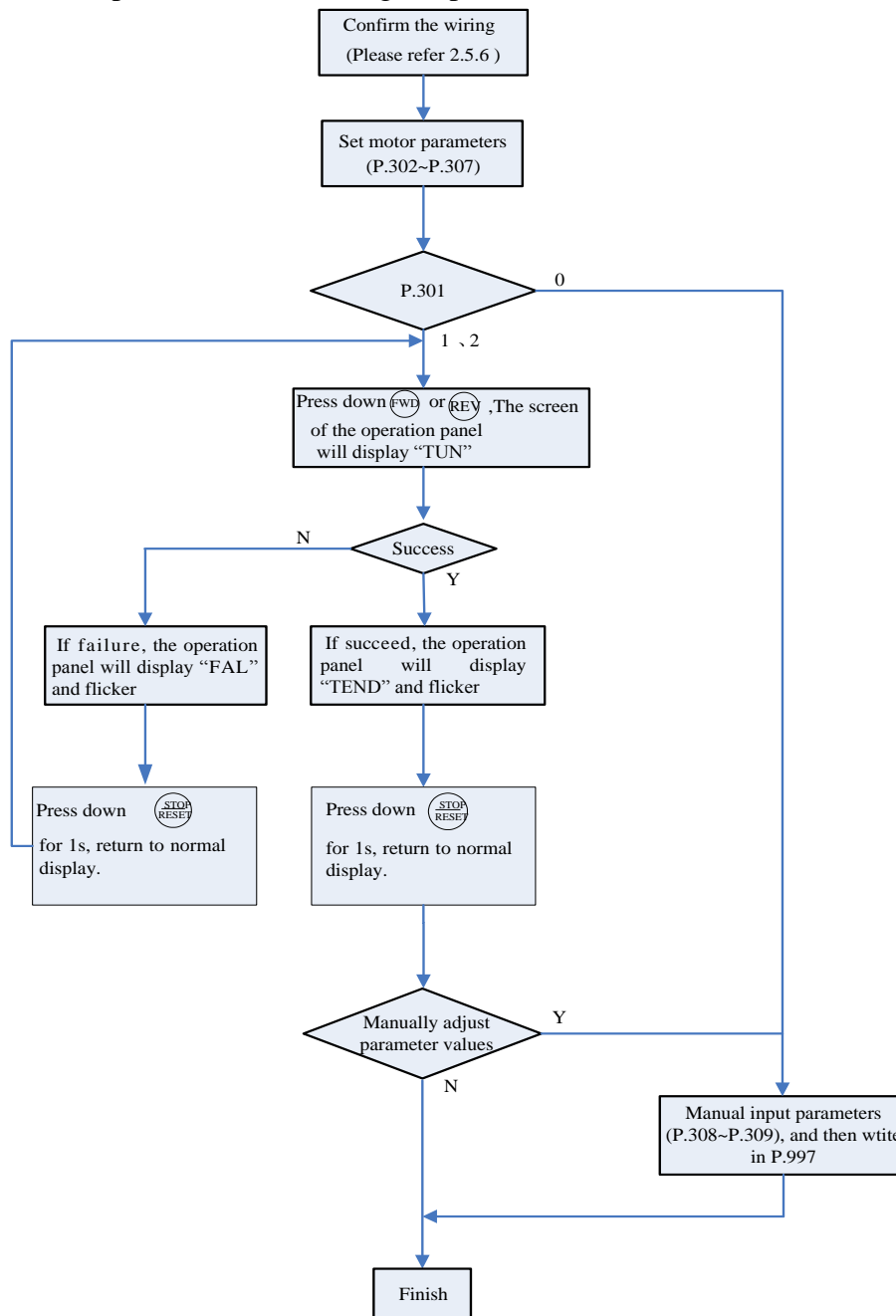

- If you need real sensorless vector control, you should set P.300 to 3.

Note: 1.The motor capacity has to be at the same level or one level below of the level of the capacity of the inverter.

2. For the auto-tuning function, if motor operation is permitted, set P.301 to 1 (dynamic measurement). At this point, the load has to be separated from the motor. If the load environment does not permit auto-tuning, set P.301 to 2 (static measurement) if motoring is running.

3. Real sensorless vector control: measurement by automatic (Auto-tuning) function to enhance the control performance. Set the motor parameters or do auto measurement function before set P.300 to 3, in order to increase the control accuracy.

5.75 Motor Parameter (P.302~P.309)

P.302 “Motor rated power”

P.306 “Motor rated current”

P.303 “Motor poles”

P.307 “Motor rated rotation speed”

P.304 “Motor rated voltage”

P.308 “Motor excitation current”

P.305 “Motor rated frequency”

P.309 “Stator resistance”

Parameter	Factory setting	Setting range	Remarks
302	0	0~160	---
303	4	0~8	---
304	220/440V	0~440V	---
305	50Hz	0~650Hz	P.189=1
	60Hz		P.189=0
306	Horsepower-based	0~500A	---
307	1410 r/min	0~9998 r/min	P.189=1
	1710 r/min		P.189=0
308	Horsepower-based	0~500A	---
309	Horsepower-based	99.98Ω	---

<Setting>

- When the motor can be fully separated from the load, select P.301=1. When the motor is running, the motor parameter will carry out auto-tuning. Then press FWD or REV on the keyboard panel for the inverter to automatically calculate the following parameter: P.308~P.309.
- When the motor cannot be fully separated from the load, select P.301=2. When the motor is stopped, the motor parameter will carry out auto-tuning. Then press FWD or REV on the keyboard panel for the inverter to automatically calculate the following parameter P.308~P.309.
- The users can use the motor's nameplate to calculate the idling current. The motor nameplate parameters used in the calculation are: rated voltage U, rated current I, rated frequency f and power factor η .

$$\text{Idling current: } I_0 = I \times \sqrt{1 - \eta^2}$$

Note: 1. When the inverter is used with a motor of a different level, verify the input motor's nameplate parameter P.302~P.307. The vector control method is heavily dependent upon motor parameters. To achieve a good control performance, the controlled motor's correct parameters have to be acquired.

2. When any or many values of P.302~P.309 are manually revised, perform the function of P.997 to reload the new values of the parameters.

5.76 Sliding Compensation Gain (P.320)

P.320” Sliding compensation gain”

Parameter	Factory setting	Setting range	Remarks
320	80%	0~200%	---

< Setting >

- P.320 is used to set sliding compensation gain coefficient. The bigger the value is set, the bigger the sliding compensation is.

5.77 Torque Compensation Filter (P.321)

P.321” Torque compensation filter coefficient”

Parameter	Factory setting	Setting range	Remarks
321	16	0~32	---







< Setting >

- P.321 is used to set torque compensation filter coefficient. The bigger the value is set, the bigger the filter is.

5.78 Parameter Copy Function (Pr.CP and Pr.CA) (DU06 operation panel needs to be purchased)

Pr.CP “Parameter copy readout”

Pr.CA “Parameter copy write-in”





- Parameter copy function is valid only when the motor is stop, P.77=0, and under the PU mode. If several inverters need set same parameter values, just only set one inverter parameters, then use Pr.CP and Pr.CA to quickly copy the values to other inverters.
- Parameter copy operation procedure:
 1. When the first inverter is in the PU mode, press  to switch to the parameter setting mode. Rotate  until **Pr.CP** is displayed, and it will displays “0” after pressing . Then rotate  to change the value to “1” and write in by pressing . The screen will display the parameter number one by one. Those indicating the parameters are copied from the inverter to the operation panel. When the parameter copying is completed the screen will display **End** and flickering.
 2. When the second inverter is in the PU mode, after **Pr.CA** is read out, the screen of the panel will display the initial value “0”. Rotate  to change the value to “1” and write in by pressing . The screen will display the parameter number one by one. Those indicating the parameters are copied from the operation panel

to the inverter. When the parameter copying is completed the screen will display *E n d* and flickering.

- Note: 1. If the version of the inverter is updated, pick inverter parameters of the lower version inverter among inverters of different versions for parameter copying.
2. Parameters cannot be copied between inverters of different series.
3. When parameters cannot be copied, DU06 operation panel will display the alarm code or “Err”. These alarm codes are not the abnormal alarm codes. When these alarm codes are displayed, inverter reset is not required.





5.79 Alarm History Clear (P.996)

P.996 “Alarm history clear”

- Once P.996 is read-out (after reading out the parameter, the screen will display *E r . E L*) and rewrite it. All the abnormal record will be erased.
- The usage method for the alarm history clear function of DU06 is as follows:
Press  to switch to the parameter setting mode, and then rotate  until *E r . E L* is displayed. After pressing , 0 will be displayed. After that, rotate  to change the value to 1 and press  to write in. At last, all the alarm history will be cleared.

5.80 Inverter Reset (P.997)

P.997 “Inverter reset”

- Once P.997 is read-out (after the read-out, the screen will display *r E S E T*) and rewritten-in, the inverter is reset. After resetting the inverter, the values of the two relays, “electronic thermal relay” and “IGBT module thermal relay”, will be set to zero.
- The usage method for the inverter reset function of DU06 is as follows:
Press  to switch to the parameter setting mode, and then rotate  until *r E S E T* is displayed. After pressing , 0 will be displayed. After that, rotate  to change the value to 1 and press  to write in that the inverter will be reset. After that, the thermal accumulation value of the electronic thermal relay capacity and the electronic thermal relay of the inverter’s IGBT module will return to zero.

5.81 Restoration of the Parameters to the Default Values (P.998 and P.999)

P.998 “Restoring all parameters to default values”

P.999 “Restoring some parameters to default values”

- Once P.998 is read-out (after the read-out, the screen will display $\overline{A L L L}$) and rewritten-in, all the parameters will be restored to the default values except P.21, P.188, P.189, P.292 and P.293.
- Once P.999 is read-out (after the read-out, the screen will display $\overline{P r L r}$) and rewritten-in, all the parameters will be restored to the default values except P.21, P.188, P.189, P.190~P.191, P.192~P.195, P.196~P.199, P.292, P.293 and P.300~P.309.
- After performing P.998 and P.999, the screen will display $\overline{E n d}$, indicating that parameters have been restored to the default values.
- The usage method for the function of restoring all parameters to default values with DU06 is as follows:
Press MODE to switch to the parameter setting mode, and then rotate ▲ until $\overline{A L L L}$ is displayed. After pressing SET , 0 will be displayed. After that, rotate ▲ to change the value to 1 and press SET to write in that all the parameters except P.21, P.188, P.189, P.292, P.293 will be restored to the default value.
- The usage method for the function of restoring some parameters to default values with DU06 is as follows:
Press MODE to switch to the parameter setting mode, and then rotate ▲ until $\overline{P r L r}$ is displayed. After pressing SET , 0 will be displayed. After that, rotate ▲ to change the value to 1 and press SET to write in that all the parameters except P.21, P.188, P.189, P.190~P.199, P.292, P.293, P.300~P.309 will be restored to the default value.
- When the operation of restoring all parameters to default values and restoring some parameters to default values is carried out, please make sure that other operations are done after $\overline{E n d}$ is displayed on the screen (including DU06) which means that the parameters have restored to default values.

Note: The parameter P.998 is only executable in the PU mode. For the flow chart of transferring operation modes, please refer to 4.1.1.

6. Inspection and Maintenance

In order to avoid the malfunction and security problems resulting from aging of the devices which is caused by environmental factors such as temperature, oil fog, dust, vibration, humidity and etc., 'daily inspection' and 'periodical inspection' are necessary.

Note: Only fully-qualified electrical professional personnel can carry out installation, wiring, dismantling and maintenance.

6.1 Daily Inspection

1. Check whether the surrounding conditions are normal (including temperature, humidity, dust density and etc.) at the installment place.
2. Check whether the power supply voltage is normal (the voltages among R/L1, S/L2 and T/L3).
3. Check whether wiring is ok (whether the external wiring for the main-circuit board and the control-board terminal is loose).
4. Check whether the cooling system is abnormal (Whether there's any abnormal acoustic noise when operating. whether the wiring is ok).
5. Check the indicating lamp (Whether the control-board indicating LED lamp, the operation panel indicating LED lamp and the operation panel screen LED are normal).
6. Check whether the expected performance is maintained.
7. Check whether there's any abnormal vibration, acoustic noise or smell during running.
8. Check whether there is liquid leaking from the filter capacitors.

6.2 Periodical Inspection (During Stop)

1. Check the connector and wiring (whether the connector and wiring between the main-circuit board and control board is ok).
2. Check whether components on the main-circuit board and the control board are overheated.
3. Check whether the electrolytic capacitors on the main-circuit board and control board have liquid leaking out.
4. Check the IGBT module on the main-circuit board.
5. Clean the dust and contaminants on the circuit board.
6. Check the insulation resistor.
7. Check whether the cooling system is abnormal (Whether the wiring is firm; clean the air filter, etc).
8. Check screws and belts.
9. Check the external wires and the terminal banks for damage.

6.3 Regular Replacement for Some Components

Items	The corresponding period for replacement	Description
Cooling fan	2 years	For the axle of a fan, the standard lifetime is about 10~35 thousand hours. With reference to the time of 24 hours one day, it is sure that the fan should be replaced every 2 years.
Filter capacitor	5 years	The filter capacitor is an electrolytic capacitor, and will deteriorate with time. The deterioration speed is contingent on the ambient conditions. Generally, it shall be replaced every 5 years.
Relay	---	If bad contact occurs, please replace it immediately.

Note: Please send the inverters to the factory when replacement of the parts is necessary.

6.4 Inverter Insulation Resistance Measurement

1. Before measurement, first dismount the 'wiring of the main-circuit Terminals' and the 'control board'. Then execute wiring in the way as the right figure.
2. The measurement is only suitable for the main circuit. Such measurement is prohibited for control board terminals.
3. The value of the insulation resistance shall be greater than $5M\Omega$.

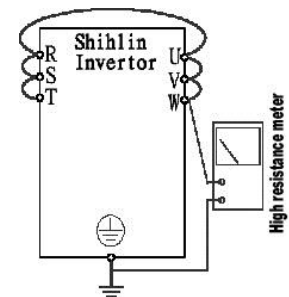

Note: Please do not carry out a high-voltage test, because the built-in semiconductor components will be damaged by such a test.

6.5 Motor insulation resistance measurement

1. Before measurement, please dismount the motor, and demonstrate wiring as the right figure.
2. The insulation resistance shall be greater than $5M\Omega$.

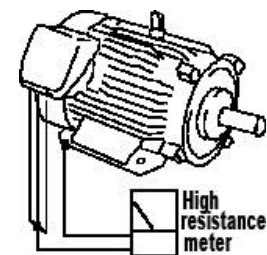

6.6 IGBT Module Test

Before check, first dismount the external wires for the main-circuit terminals. Then, set your multi-meter to the ohm-testing position.

	Positive voltage	Negative voltage	Normal result		Positive voltage	Negative voltage	Normal result
Terminal mark	R/L1	+P	Conducting	Terminal mark	U/T1	+P	Conducting
	S/L2	+P	Conducting		V/T2	+P	Conducting
	T/L3	+P	Conducting		W/T3	+P	Conducting
	+P	R/L1	Not conducting		+P	U/T1	Not conducting
	+P	S/L2	Not conducting		+P	V/T2	Not conducting
	+P	T/L3	Not conducting		+P	W/T3	Not conducting
	R/L1	-N	Not conducting		U/T1	-N	Not conducting
	S/L2	-N	Not conducting		V/T2	-N	Not conducting
	T/L3	-N	Not conducting		W/T3	-N	Not conducting
	-N	R/L1	Conducting		-N	U/T1	Conducting
	-N	S/L2	Conducting		-N	V/T2	Conducting
	-N	T/L3	Conducting		-N	W/T3	Conducting

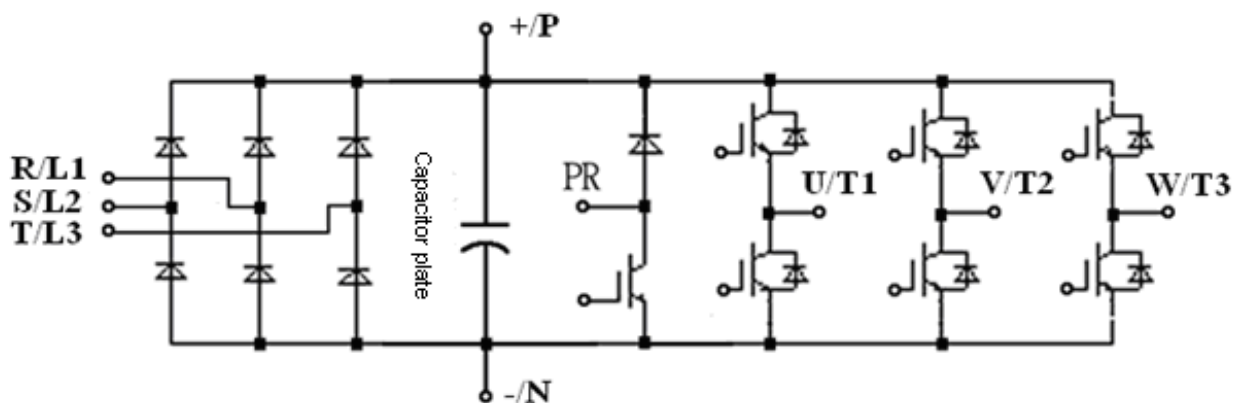

Appendix 1 Parameter list

Parameter number	Name	Setting range	Minimum setting unit	Default value	User setting value	Reference page
P.0	Torque boost	0~30%	0.1%	(Note)		P47
P.1	Maximum frequency	0~120Hz	0.01Hz	120Hz		P48
P.2	Minimum frequency	0~120Hz	0.01Hz	0Hz		P48
P.3	Base frequency	0~650Hz	0.01Hz	50Hz/60Hz (Note)		P49
P.4	Speed 1 (high speed)	0~650Hz	0.01Hz	60Hz		P50
P.5	Speed 2 (medium speed)	0~650Hz	0.01Hz	30Hz		P50
P.6	Speed 3 (low speed)	0~650Hz	0.01Hz	10Hz		P50
P.7	Acceleration time	0~360.00s/ 0~3600.0s	0.01s/0.1s	5s (3.7KW and below) 10s (5.5KW)		P51
P.8	Deceleration time	0~360.00s/ 0~3600.0s	0.1s/0.01s	5s (3.7KW and below) 10s (5.5KW)		P51
P.9	Electronic thermal relay capacity	0~500A	0.01A	0A		P53
P.10	DC injection brake operation frequency	0~120Hz	0.01Hz	3Hz		P54
P.11	DC injection brake operation time	0~60s	0.1s	0.5s		P53
P.12	DC injection brake operation voltage	0~30%	0.1%	4%		P53
P.13	Starting frequency	0~60Hz	0.01Hz	0.5Hz		P54
P.14	Load pattern selection	0~13	1	0		P55
P.15	JOG frequency	0~650Hz	0.01Hz	5Hz		P58
P.16	JOG acceleration / deceleration time	0~360.00s/ 0~3600.0s	0.1s/0.01s	0.5s		P58
P.17	Input signal across terminal 4-5 selection	0~2	1	0		P87
P.18	High-speed maximum frequency	120~650Hz	0.01Hz	120Hz		P48

Appendix 1 Parameter list

Parameter number	Name	Setting range	Minimum setting unit	Default value	User setting value	Reference page
P.19	Base frequency voltage	0~1000V, 9999	0.1V	9999		P49
P.20	Acceleration/deceleration reference frequency	1~650Hz	0.01Hz	50Hz/60Hz (Note)		P51
P.21	Acceleration/deceleration time increments	0,1	1	0		P51
P.22	Stall prevention operation level	0~250%	0.1%	200%		P58
P.23	Compensation factor at level reduction	0~200%, 9999	0.1%	9999		P58
P.24	Speed 4	0~650Hz, 9999	0.01Hz	9999		P50
P.25	Speed 5	0~650Hz, 9999	0.01Hz	9999		P50
P.26	Speed 6	0~650Hz, 9999	0.01Hz	9999		P50
P.27	Speed 7	0~650Hz, 9999	0.01Hz	9999		P50
P.28	Output frequency filter constant	0~31	1	0		P59
P.29	Acceleration/deceleration curve selection	0~3	1	0		P60
P.30	Regenerative brake function selection	0, 1	1	0		P63
P.31	Soft-PWM selection	0~2	1	0		P63
P.32	Serial communication Baud rate selection	0~3	1	1		P64
P.33	Communication protocol selection	0, 1	1	0		P64
P.34	Communication EEPROM writing selection	0	1	0		P64
		1				
P.35	Communication Running and Speed Command Selection	1	1	0		P82
P.36	Inverter station number	0~254	1	0		P64
P.37	Speed display	0~5000.0r/min	0.1r/min	0 r/min		P82
		0~9999r/min	1r/min			

Appendix 1 Parameter list

Parameter number	Name	Setting range	Minimum setting unit	Default value	User setting value	Reference page
P.38	The maximum operation frequency (the target frequency is set by the input signal of terminal 2-5)	1~650Hz	0.01Hz	50Hz/60Hz (Note)		P83
P.39	The maximum operation frequency (the target frequency is set by the input signal of terminal 4-5)	1~650Hz	0.01Hz	50Hz/60Hz (Note)		P87
P.40	Multi-function output terminal pattern	0~12, 17,18,41	1	0		P88
P.41	Up-to-frequency sensitivity	0~100%	0.1%	10%		P91
P.42	Output frequency detection for forward rotation	0~650Hz	0.01Hz	6Hz		P92
P.43	Output frequency detection for reverse rotation	0~650Hz, 9999	0.01Hz	9999		P92
P.44	The second acceleration time	0~360.00s/ 0~3600.0s,9999	0.01s/0.1s	9999		P51
P.45	The second deceleration time	0~360.00s/ 0~3600.0s,9999	0.01s/0.1s	9999		P51
P.46	The second torque boost	0~30%,9999	0.1%	9999		P47
P.47	The second base frequency	0~650Hz, 9999	0.01Hz	9999		P49
P.48	Data length	0, 1	1	0		P64
P.49	Stop bit length	0, 1	1	0		P64
P.50	Parity check selection	0, 1, 2	1	0		P64
P.51	CR & LF selection	1, 2	1	1		P64

Appendix 1 Parameter list

Parameter number	Name	Setting range	Minimum setting unit	Default value	User setting value	Reference page
P.52	Number of communication retries	0~10	1	1		P64
P.53	Communication check time interval	0~999.8s, 9999	0.1s	9999		P64
P.54	AM terminal function selection	0~5	1	0		P93
P.55	Frequency display reference	0~650Hz	0.01Hz	50Hz/60Hz (Note)		P93
P.56	Current monitoring reference	0~500A	0.01A	Rated output current		P93
P.57	Restart coasting time	0~30s, 9999	0.1s	9999		P94
P.58	Restart cushion time	0~60s	0.1s	10s		P129
P.59	The choice of locking operation keyboard knob setting	0,1,10,11,100,101,110,111,200,201,210,211,1000,1001,1010,1011,1100,1101,1110,1111,1200,1201,1210,1211	1	0		P95
P.60	Input signal filtering constant	0~31	1	31		P96
P.61	Remote setting function selection	0~4,11~14	1	0		P96
P.62	Zero current detection level	0~200%, 9999	0.1%	5%		P99
P.63	Zero current detection time	0.05~60s, 9999	0.01s	0.5s		P99
P.64	Pulse output selection	0,1	1	0		P88
P.65	Retry selection	0~4	1	0		P100
P.66	Stall prevention operation reduction starting frequency	0~650Hz	0.01Hz	50Hz/60Hz (Note)		P58
P.67	Number of retries at alarm occurrence	0~10	1	0		P100
P.68	Retry waiting time	0~360s	0.1s	6s		P100

Appendix 1 Parameter list

Parameter List

Parameter number	Name	Setting range	Minimum setting unit	Default value	User setting value	Reference page
P.69	Retry accumulation time at alarm	0	0	0		<u>P100</u>
P.70	Special regenerative brake duty	0~30%	0.1%	0		<u>P63</u>
P.71	Idling braking and linear braking selection	0, 1	1	1		<u>P101</u>
P.72	Carrier frequency	1~15	1	5		<u>P102</u>
P.73	Voltage signal selection	0, 1	1	0		<u>P83</u>
P.74	10X output selection	0~10	1	0		<u>P88</u>
P.75	Stop or Reset function selection	0~1	1	1		<u>P103</u>
P.77	Parameters write protection	0~2, 4	1	0		<u>P103</u>
P.78	Forward/reverse rotation prevention selection	0, 1, 2	1	0		<u>P104</u>
P.79	Operation mode selection	0~8	1	0		<u>P104</u>
P.80	Multi-function terminal M0 function selection	0~40,43~45	1	2		<u>P105</u>
P.81	Multi-function terminal M1 function selection	0~40,43~45	1	3		<u>P105</u>
P.82	Multi-function terminal M2 function selection	0~40,43~45	1	4		<u>P105</u>
P.83	Multi-function terminal STF function selection	0~40,43~45	1	0		<u>P105</u>
P.84	Multi-function terminal STR function selection	0~40,43~45	1	1		<u>P105</u>
P.85	Function selection for multi-function relay	0~12,17,18,41	1	5		<u>P88</u>
P.86	Multi-function terminal RES function selection	0~40,43~45	1	30		<u>P105</u>

Appendix 1 Parameter list

Parameter number	Name	Setting range	Minimum setting unit	Default value	User setting value	Reference page
P.87	Multi-Function Control -Terminal Input Positive/Negative Logic	0~63	1	0		P110
P.88	Multi-function output terminal positive/negative logic	0~3	1	0		P110
P.89	Slip compensation coefficient	0~10	1	0		P111
P.90	The inverter model	---	---	---		P111
P.91	Frequency jump 1A	0~650Hz, 9999	0.01Hz	9999		P112
P.92	Frequency jump 1B	0~650Hz, 9999	0.01Hz	9999		P112
P.93	Frequency jump 2A	0~650Hz, 9999	0.01Hz	9999		P112
P.94	Frequency jump 2B	0~650Hz, 9999	0.01Hz	9999		P112
P.95	Frequency jump 3A	0~650Hz, 9999	0.01Hz	9999		P112
P.96	Frequency jump 3B	0~650Hz, 9999	0.01Hz	9999		P112
P.97	The second frequency source	0~2	1	0		P112
P.98	Middle frequency 1	0~650Hz	0.01Hz	3Hz		P55
P.99	Output voltage 1 of middle frequency	0~100%	0.1	10		P55
P.100	Minute/second selection	0, 1	1	1		P113
P.101	Runtime of section 1 in programmed operation mode	0~6000s	0.1s	0s		P113
P.102	Runtime of section 2 in programmed operation mode	0~6000s	0.1s	0s		P113
P.103	Runtime of section 3 in programmed operation mode	0~6000s	0.1s	0s		P113
P.104	Runtime of section 4 in programmed operation mode	0~6000s	0.1s	0s		P113

Appendix 1 Parameter list

Parameter number	Name	Setting range	Minimum setting unit	Default value	User setting value	Reference page
P.105	Runtime of section 5 in programmed operation mode	0~6000s	0.1s	0s		P113
P.106	Runtime of section 6 in programmed operation mode	0~6000s	0.1s	0s		P113
P.107	Runtime of section 7 in programmed operation mode	0~6000s	0.1s	0s		P113
P.108	Runtime of section 8 in programmed operation mode	0~6000s	0.1s	0s		P113
P.110	Operation panel monitoring selection	0~5	1	0		P115
P.111	Acceleration/deceleration time of section 1	0~600s/0~6000s	0.01s/0.1s	0s		P113
P.112	Acceleration/deceleration time of section 2	0~600s/0~6000s	0.01s/0.1s	0s		P113
P.113	Acceleration/deceleration time of section 3	0~600s/0~6000s	0.01s/0.1s	0s		P113
P.114	Acceleration/deceleration time of section 4	0~600s/0~6000s	0.01s/0.1s	0s		P113
P.115	Acceleration/deceleration time of section 5	0~600s/0~6000s	0.01s/0.1s	0s		P113
P.116	Acceleration/deceleration time of section 6	0~600s/0~6000s	0.01s/0.1s	0s		P113
P.117	Acceleration/deceleration time of section 7	0~600s/0~6000s	0.01s/0.1s	0s		P113
P.118	Acceleration/deceleration time of section 8	0~600s/0~6000s	0.01s/0.1s	0s		P113
P.119	The dead time of positive and reverse rotation	0~3000s	0.1s	0s		P116
P.120	Output signal delay time	0~3600s	0.1s	0s		P88
P.121	Run direction in each section	0~255	1	0		P113
P.122	Cycle selection	0~8	1	0		P113

Appendix 1 Parameter list

Parameter number	Name	Setting range	Minimum setting unit	Default value	User setting value	Reference page
P.123	Acceleration/deceleration time setting selection	0, 1	1	0		P113
P.131	Frequency of section 1	0~650Hz	0.01Hz	0Hz		P113
P.132	Frequency of section 2	0~650Hz	0.01Hz	0Hz		P113
P.133	Frequency of section 3	0~650Hz	0.01Hz	0Hz		P113
P.134	Frequency of section 4	0~650Hz	0.01Hz	0Hz		P113
P.135	Frequency of section 5	0~650Hz	0.01Hz	0Hz		P113
P.136	Frequency of section 6	0~650Hz	0.01Hz	0Hz		P113
P.137	Frequency of section 7	0~650Hz	0.01Hz	0Hz		P113
P.138	Frequency of section 8	0~650Hz	0.01Hz	0Hz		P113
P.139	Voltage signal bias	0%~100%	0.1%	0%		P83
P.140	Voltage signal gain	0.1%~200%	0.1%	100%		P83
P.141	Voltage signal bias direction and rotational direction setup	0~11	1	0		P83
P.142	Speed 8	0~650Hz	0.01Hz	0Hz		P50
P.143	Speed 9	0~650Hz, 9999	0.01Hz	9999		P50
P.144	Speed 10	0~650Hz, 9999	0.01Hz	9999		P50
P.145	Speed 11	0~650Hz, 9999	0.01Hz	9999		P50
P.146	Speed 12	0~650Hz, 9999	0.01Hz	9999		P50
P.147	Speed 13	0~650Hz, 9999	0.01Hz	9999		P50
P.148	Speed 14	0~650Hz, 9999	0.01Hz	9999		P50
P.149	Speed 15	0~650Hz, 9999	0.01Hz	9999		P50
P.150	Restart mode selection	0~22	1	0		P94
P.151	Zero-speed control function selection	0, 1	1	0		P117
P.152	Voltage instruction at zero-speed control	0~30%	0.1%	5%		P117
P.153	Communication error handling	0, 1	1	0		P64

Appendix 1 Parameter list

Parameter number	Name	Setting range	Minimum setting unit	Default value	User setting value	Reference page
P.154	Modbus communication data format	0~5	1	4		P64
P.155	Over torque detection level	0~200%	0.1%	0%		P118
P.156	Over torque detection time	0~60s	0.1s	1s		P118
P.157	External terminals filter adjusting function	0~200ms	1ms	4ms		P119
P.158	External terminal power enable	0, 1	1	0		P119
P.159	energy-saving control function	0, 1	1	0		P119
P.161	Multi-function display selection	0~9, 11~13, 19~21	1	0		P120
P.162	Middle frequency 2	0~650Hz, 9999	0.01Hz	9999		P55
P.163	Output voltage 2 of middle frequency	0~100%	0.1%	0		P55
P.164	Middle frequency 3	0~650Hz, 9999	0.01Hz	9999		P55
P.165	Output voltage 3 of middle frequency	0~100%	0.1%	0		P55
P.166	Middle frequency 4	0~650Hz, 9999	0.01Hz	9999		P55
P.167	Output voltage 4 of middle frequency	0~100%	0.1%	0		P55
P.168	Middle frequency 5	0~650Hz, 9999	0.01Hz	9999		P55
P.169	Output voltage 5 of middle frequency	0~100%	0.1%	0		P55
P.170	PID function selection	0, 1, 2	1	0		P121
P.171	PID feedback control method selection	0, 1	1	0		P121
P.172	PID proportion Gain	1~100	1	20		P121
P.173	PID integration Gain	0~100s	0.1s	1s		P121
P.174	PID differential Gain	0~1000ms	1ms	0 ms		P121

Appendix 1 Parameter list

Parameter number	Name	Setting range	Minimum setting unit	Default value	User setting value	Reference page
P.175	Abnormal deviation level	0~100%	0.1%	0		P121
P.176	Exception duration time	0~600s	0.1s	0s		P121
P.177	Exception handling mode	0, 1,2	1	0		P121
P.178	Sleep detects deviation	0~100%	0.1%	0		P121
P.179	Sleep detects duration time	0~255s	0.1s	0s		P121
P.180	Revival level	0~100%	0.1%	90%		P121
P.181	Outage level	0~120Hz	0.01Hz	40Hz		P121
P.182	Integral upper limit frequency	0~120Hz	0.01Hz	50Hz/60Hz (Note)		P121
P.183	Deceleration step length with stable pressure	0~10Hz	0.01Hz	0.5Hz		P121
P.184	4-5 terminal disconnection handling	0~3	0	0		P126
P.185	Proportion linkage gain	0~100%	1	0		P127
P.187	FM calibration parameter	0~9998	1	220		P88
P.188	Firmware version	---	---	---		P127
P.189	Factory setting function	0, 1	1	60Hz	0	P128
				50Hz	1	
P.190	AM output bias	0~8192	1	0		P93
P.191	AM output gain	0~8192	1	600		P93
P.192	2-5 terminal minimum input voltage	0~10	0.01	0		P129
P.193	2-5 terminal maximum input voltage	0~10	0.01	0		P129
P.194	Frequency corresponds to the minimum input voltage of terminal 2-5	0~60Hz	0.01Hz	0Hz		P129
P.195	Frequency corresponds to the maximum input voltage of terminal 2-5	0~650Hz	0.01Hz	50Hz/60Hz (Note)		P129

Appendix 1 Parameter list

Parameter number	Name	Setting range	Minimum setting unit	Default value	User setting value	Reference page
P.196	Frequency corresponds to the minimum input current/voltage across terminal 4-5	0~60Hz	0.01Hz	0Hz		P130
P.197	Frequency corresponds to the maximum input current /voltage across terminal 4-5	0~650Hz	0.01Hz	50Hz/60Hz (Note)		P130
P.198	Minimum input current/voltage across terminal 4-5	0~20	0.01	0		P130
P.199	Maximum input current/voltage across terminal 4-5	0~20	0.01	0		P130
P.219	Remote function acc/dec time selection	0~1	1	0		P96
P.223	Analog feedback bias pressure	0~100%	0.1	0%		P121
P.224	Analog feedback gain pressure	0~100%	0.1	100%		P121
P.225	Panel command	0~P.251,9999	0.1	20%		P121
P.226	The paver function selection	0, 1	1	0		P131
P.227	The limit time of positive rotation	0~3600s	0.1 s	0		P131
P.228	The limit time of reverse rotation	0~3600s	0.1 s	0		P131
P.229	Backlash compensation and acceleration/deceleration interrupted for waiting function selection	0~2	1	0		P132
P.230	The acceleration interrupt frequency	0~650Hz	0.01Hz	1Hz		P132
P.231	The acceleration interrupt time	0~360s	0.1s	0.5s		P132
P.232	The deceleration interrupt frequency	0~650Hz	0.01Hz	1Hz		P132
P.233	The deceleration interrupt time	0~360 s	0.1s	0.5s		P132
P.234	Triangular wave function selection	0~2	1	0		P134
P.235	Maximum amplitude	0~25%	0.1%	10%		P134

Appendix 1 Parameter list

Parameter number	Name	Setting range	Minimum setting unit	Default value	User setting value	Reference page
P.236	Amplitude compensation for deceleration	0~50%	0.1%	10%		P134
P.237	Amplitude compensation for acceleration	0~50%	0.1%	10%		P134
P.238	Amplitude acceleration time	0~360s /0~3600 s	0.01 s/0.1s	10 s		P134
P.239	Amplitude deceleration time	0~360s /0~3600 s	0.01 s/0.1s	10s		P134
P.240	Auxiliary frequency function selection	0~6	1	0		P135
P.242	DC injection brake function before starting selection	0~1	1	0		P135
P.243	DC injection brake time before starting	0~60s	0.1s	0.5s		P135
P.244	DC injection brake voltage before starting	0~30%	0.1%	4%		P135
P.245	Cooling fan operation selection	0~3	0	0		P136
P.247	MC switchover interlock time	0.1~100s	0.1s	1s		P137
P.248	Start waiting time	0.1~100s	0.1s	0.5s		P137
P.249	Automatic switchover frequency from inverter to commercial power supply frequency	0~60Hz,9999	0.01Hz	9999		P137
P.250	Automatic switchover frequency range from commercial power supply to inverter	0~10Hz,9999	0.01Hz	9999		P137
P.251	PID maximum	1.0~100.0	0.1	100.0		P121
P.253	Analog signal feedback loss detection time	0.0~600.0s	0.1s	0.0s		P121
P.254	Analog signal feedback loss action selection	0~2	1	0		P121
P.255	S pattern time at the beginning of acceleration	0~25s	0.01s/0.1s	0.2s		P60
P.256	S pattern time at the end of acceleration	0~25s,9999	0.01s/0.1s	9999		P60
P.257	S pattern time at the beginning of deceleration	0~25s,9999	0.01s/0.1s	9999		P60

Appendix 1 Parameter list

Parameter List







Parameter number	Name	Setting range	Minimum setting unit	Default value	User setting value	Reference page
P.258	S pattern time at the end of deceleration	0~25s,9999	0.01s/0.1s	9999		P60
P.259	Speed unit selection	0, 1	1	1		P82
P.260	Over torque detection selection	0, 1	1	1		P118
P.261	Maintenance Alarm Time	0~9998day	1	0		P137
P.268	Voltage stall level	155~410V : 220V model	1V	380V		P140
		310~820V : 440V model	1V	760V		P140
P.286	High frequency vibration inhibition factor	0~15	1	0		P140
P.287	Short circuit protection function selection	0~1	1	1		P141
P.288	Alarm code display option	0~12	1	0		P141
P.289	Alarm code	---	---	0		P141
P.290	The latest alarm status selection	0~6	1	0		P141
P.291	The latest alarm message	---	---	0		P141
P.292	Accumulative motor operation time (minutes)	0~1439min	1min	0 min		P142
P.293	Accumulative motor operation time (days)	0~9998day	1day	0 day		P142
P.294	Decryption parameter	0~9998	1	0		P142
P.295	Password setup	2~9998	1	0		P142
P.300	Motor control mode selection	0~2	1	0		P143
P.301	Motor parameter auto-tuning function selection	0~3	1	0		P143
P.302	Motor rated power	0~160	0.01	0		P145
P.303	Motor poles	0~8	1	4		P145
P.304	Motor rated voltage	0~440V	1 V	220/440V		P145
P.305	Motor rated frequency	0~650Hz	0.01Hz	50Hz/60Hz (Note)		P145
P.306	Motor rated current	0~500A	0.01 A	Horsepower-based		P145

Appendix 1 Parameter list

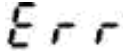
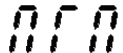
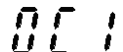
Parameter number	Name	Setting range	Minimum setting unit	Default value	User setting value	Reference page
P.307	Motor rated rotation speed	0~9998 r/min	1 r/min	1410/1710 r/min (Note)		P145
P.308	Motor excitation current	0~500A	0.01 A	Horsepower-based		P145
P.309	Stator resistance	0~99.98Ω	1Ω	Horsepower-based		P145
P.320	Sliding compensation gain	0~200%	1%	80%		P146
P.321	Torque compensation filter coefficient	0~32	1	16		P146
P.996	Alarm history clear	Refer to Chapter 5	---	---	---	P147
P.997	Inverter reset	Refer to Chapter 5	---	---	---	P147
P.998	Restoring all parameters to default values	Refer to Chapter 5	---	---	---	P148
P.999	Restoring some parameters to default values	Refer to Chapter 5	---	---	---	P148

Note: The default value is determined by the set value of [P.189](#). When P.189=0, the default value is 60Hz, which is applicable to 60Hz systems. When P.189=1, the default value is 50Hz, which is applicable to 50Hz systems.

Appendix 2 Alarm Code List

Code	Screen Display	Cause	Troubleshooting
ERR		<ol style="list-style-type: none"> Under-voltage for power supply The RES is 'on' Bad connection between the operation panel and main machine Internal circuit malfunction Wrong operation of CPU 	<ol style="list-style-type: none"> Provide a normal power supply Shut off RES Ensure firm connection between the operation panel and the main machine Replace the inverter Restart the inverter
OC0 Over-current when starting		The output current is two times larger than the rated current of the inverter.	The inverter may be disturbed. Please restart the inverter. If the alarm repeated, please send the inverter back to the factory.
OC1 Over-current during acceleration			<ol style="list-style-type: none"> In case the time for acceleration or deceleration is too short, please prolong it. Avoid abrupt increase of load. Check Terminals U/T1, V/T2 and W/T3 for short circuit.
OC2 Over-current at constant speed			
OC3 Over-current during deceleration			
OV0 Over-voltage when stop		Over-voltage between Terminal P and Terminal N	Check whether the power supply is normal or abnormal.
OV1 Over-voltage during acceleration			<ol style="list-style-type: none"> In case the time for acceleration or deceleration is too short, please prolong it. Check the brake resistor between terminal +/P and PR for loose connection. Check whether the values of <u>P.30</u> and <u>P.70</u> are right or not.
OV2 Over-voltage at constant speed			

Appendix 2 Alarm Code List

Code	Screen Display	Cause	Troubleshooting
OV3 Over-voltage during deceleration	OV3	Over-voltage between Terminal P and Terminal N	Please refer to OV1, OV2.
THT The IGBT module is overheating	THT	The IGBT module thermal accumulating relay acts	Avoid the inverter long timely operating under overload condition
THN Motor overheating	THN	The electronic thermal relay operates	<ol style="list-style-type: none"> 1. Check whether the set value of the <u>P.9</u> is correct or not (the set value should comply the actual motor) 2. Reduce load
OHT The external thermal relay operates.	OHT	The external thermal relay operates	<ol style="list-style-type: none"> 1. Check the capacity of the external thermal relay and the motor for matching. 2. Reduce the load
OPT Peripheral devices are abnormal	OPT	<ol style="list-style-type: none"> 1. Abnormal communication. The maximum communication retry number is violated. 2. Interrupted communication. The maximum communication check time interval is violated. 	Correctly set the communication parameters
EEP Memory is abnormal	EEP	The memory ROM fails	Send it back to the factory.
CPU CPU error	CPU	External electromagnetic disturbance is too strong	Improve external disturbance
OLS Stall prevention protection	OLS	The load of the motor is too heavy.	<ol style="list-style-type: none"> 1. Reduce the load of the motor. 2. Increase the value of <u>P.22</u>.
SCP Over-current	SCP	The output current is two times larger than the rated current of the inverter.	Check Terminals U/T1, V/T2 and W/T3 for short circuit. (such as the motor wiring)

Appendix 2 Alarm Code List

Code	Screen Display	Cause	Troubleshooting
PIDE PID abnormal	PIDE	1. The capacitor of inverter and motor is not enough. 2. Setting PID target value and feed-back value unreasonable 3. peripheral equipment failure	1. Exchange a larger capacity inverter and motor. 2. Check the value which setting of PID feed-back signal Gain, setting the value again according to PID feed-back signal Gain. 3. Check whether the external feedback device (such as sensor, regulation resistance) and circuit is normal or abnormal.
NTC The IGBT module is overheating	ntc	The temperature of IGBT module is too high	1. Reduce the environment temperature and improve the air condition 2. Check whether the fan of the inverter is damaged.
CPR CPU abnormal	CPr	CPU software abnormal	1. Check the wiring. 2. Check the parameter setting. 3. Improve external disturbance.
OL2 Over torque abnormal	OL2	1. Too heavy load of motor. 2. The setting value of P.155 and P.156 is unreasonable.	1. Alleviate the load of motor. 2. Adjustment the setting value of <u>P.155</u> and <u>P.156</u> properly
AErr Abnormal of 4-5 terminal	AErr	1. The disconnection abnormal when simulation given of 4-5 terminal. 2. 4-5 terminal as PID feedback loss alarm	1. Please refer to the parameter <u>P.184</u> . 2. Please refer to the parameter <u>P.254</u> .

Note: 1. When the above alarms occur, the inverter will stop. Please deal with these alarms according to the methods mentioned above.

2. The abnormal number of alarm code can refer to P.288~P.291.

Appendix 3 Warning Code List

Code	Screen Display	Cause	Troubleshooting
Current stall		<p>When the output current is larger than Stall prevention operation level, the three lights on the left side of the screen flicker, indicating that the inverter is in current stall mode. In this case the motor may not run smoothly.</p>	<ol style="list-style-type: none"> 1. Check if the values of <u>P.22, P.23, and P.66</u> are proper. 2. Check if the values of <u>P.7 and P.8</u> are too small.
Voltage stall		<p>When the voltage between +/P and -/N is too high, the three lights on the right side of the screen flicker, indicating that the inverter is in voltage stall mode. Then the motor may not run smoothly.</p>	<ol style="list-style-type: none"> 1. Add a brake resistor between +/P and PR. 2. Check if the values of P.7 and P.8 are too small
LV Low voltage	Lu	Input voltage is low.	Supply with the normal voltage
LT motion		<p>When the output current is more than twice the rated current, but it doesn't reach the stall level, all the six lights on both side of the screen flicker, indicating that the inverter is in LT mode. Then the motor may not run smoothly.</p>	<ol style="list-style-type: none"> 1. Please increase the acceleration/deceleration time in case of abrupt acceleration/deceleration. 2. Avoid abrupt load increasing.

Note: The above warning information is to show users the working state of the inverter, and the inverter will not stop. To fix above troubles, please adjust the parameters properly or check the power supply and load carefully.

Appendix 4 Troubles and Solutions

Troubles	Check points	
Motionless motor	Main circuit	<ul style="list-style-type: none"> • Check whether the power supply voltage between Terminals R/L1, S/L2 and T/L3 is normal. • Check whether the Power light is on. • Check whether the wiring between the inverter and the motor is correct.
	Load	<ul style="list-style-type: none"> • Check whether the load is too heavy. • Check whether the motor rotor is locked.
	Parameters Setting	<ul style="list-style-type: none"> • Check whether the starting frequency (P.13) is set too big. • Check whether the operation mode (P.79) is correct. • Check whether the maximum frequency (P.1) is zero. • Check whether the reverse rotation prevention is restricted. • Check whether the bias and gain (P.192~P.199) setting is correct. • Check that the frequency jump (P.91~P.96) setting is correct.
	Control circuit	<ul style="list-style-type: none"> • Check whether the output stop signal "MRS" is on. (Related parameter P.80~P.84, P.86). • Check whether the "RES" function is ON. (Related parameter P.80~P.84, P.86). • Check whether the external thermal relay is operating or not. • Check whether the reset has been performed or not after the set-off of the alarm (the ALARM light in on). • Check whether the voltage/current signals are correctly wired. • Check whether the functions of STF and STR are correct (related parameter P.80~P.84, P.86). • Check whether the wiring for the control circuit is disconnected or has a poor contact.
Reversed motor rotation	<ul style="list-style-type: none"> • Check whether the phase sequence of output terminals U/T1, V/T2 and W/T3 is correct. • Check whether the start signal (STF and STR) are connected correctly. 	
Failure to increase the rotation speed of the motor	<ul style="list-style-type: none"> • Check whether the load is too heavy. • Check whether the stall prevention level (P.22) is correct. • Check whether the torque boost (P.0) is set too high. • Check whether the maximum frequency (P.1) is effective. 	
Unsmoothed acceleration / deceleration	<ul style="list-style-type: none"> • Check whether the acceleration / deceleration time (P.7, P.8) is correct. • Check whether the acceleration / deceleration curve selection (P.29) is correct. • Check whether the voltage / current input signals are affected by noises. 	
Overlarge motor current	<ul style="list-style-type: none"> • Check whether the load is too heavy. • Check whether the capacity of the inverter and of the motor are well matched. • Check whether the torque boost (P.0) is set too high. 	
Speed variation during the operation	<ul style="list-style-type: none"> • Check whether the voltage / current input signals are affected by noises. • Check whether the load varies. • Check whether the wiring length of the main circuit is too long. 	

Appendix 5 Optional Equipment

Operation panel, operation panel installation dimensions and transmission cable:

1. DU06 operation panel

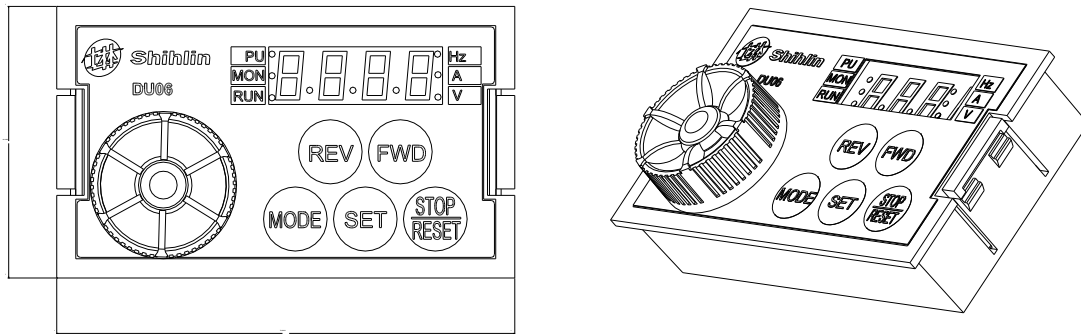

Description on the ordering code:

NO.	Model	Name
1	SNKDU06	DU06 operation panel

2. Outline drawing of DU06:

<Outline drawing>

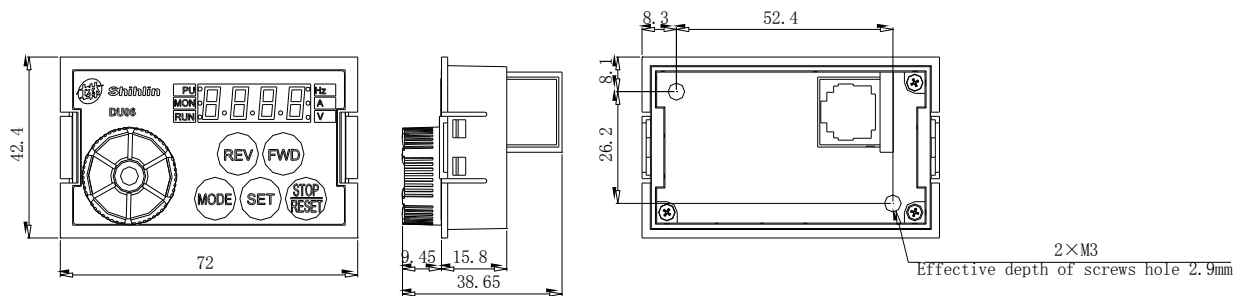

3. Screw installation of DU06:

<Screw installation: panel cutting dimension drawing>

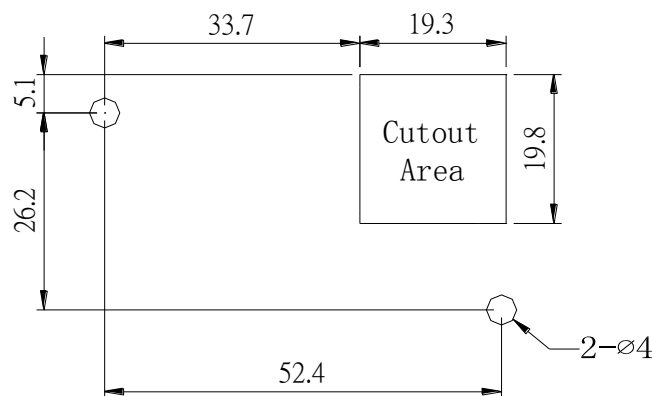

4. Snap-fit installation of DU06:

<Snap-fit installation: panel cutting dimension drawing>

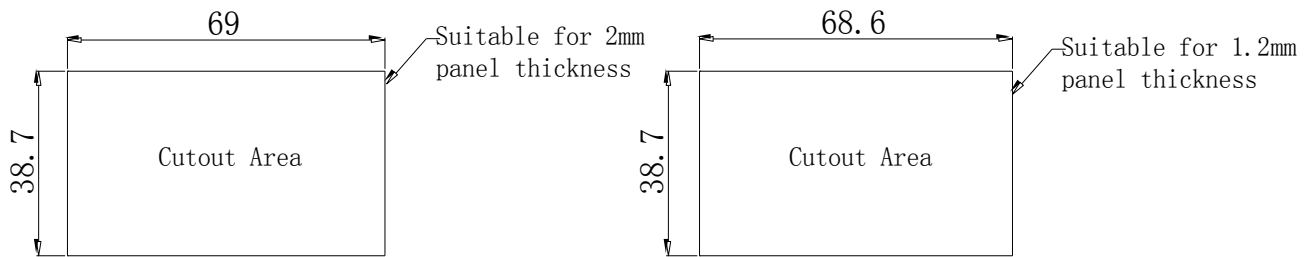

5. CBL: Transmission cable used with the above operation panel

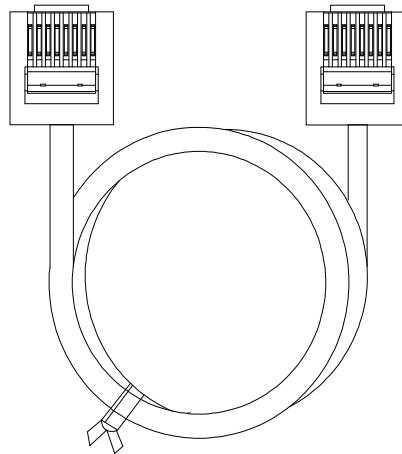

Description on the ordering code:

NO.	Model	Name	Ordering code
1	CBL1R5GT	Transmission cable (1.5M)	SNKCBL1R5GT
2	CBL03GT	Transmission cable (3M)	SNKCBL03GT
3	CBL05GT	Transmission cable (5M)	SNKCBL05GT

Appendix 6 European Specification Compatibility Description

This inverter qualifies the CE label. Specifications:

Low Voltage Directive 2014/35/EU & Electromagnetic Compatibility Directive 2014/30/EU.

1. Electromagnetic compatibility command (EMC):

(1). EMC compatibility description:

For system integration, inverter is not a functionally independent device unit. It is usually a unit in the control box. It is combined with other devices to control a machine or equipment. Therefore, our company does not consider that all the EMC commands should be directly applied on the inverter. As a result, the CE label of this inverter is not extensible.

(2). Compatibility:

The inverter does not need to cover all the EMC commands. Yet, for certain machine equipment that needs to use EMC commands and the inverter, the machine has to be equipped with CE label. In addition, the company can provide the electromagnetic inspection data and operation manual that covers the required electromagnetic compatibility specifications for a quick and easy installation of the machine equipment of this inverter.

(3). Installation outline:

Please follow the following notes for installing the inverter:

- * Use a noise filter qualifying the EU standard to coordinate with the inverter.
- * The wire between the motor and the inverter has to be stored in shielded cable or metal tube. In addition, ground the motor terminal and the inverter terminal together. Please shorten the wire as much as possible.
- * Please put this inverter in a metal cabinet that is already grounded. It can prevent radiation interference.
- * The line-to-line noise filter at the power source terminal and the online magnetic iron core at the control row are used for suppressing noises.

All the signals and the EU-qualified filter specifications are described in details in the operation manual. Please contact your agent.

2. Low-voltage command (LVD):

(1). Low-voltage command compatibility description:

This inverter is compatible with low-voltage commands.

(2). Compatibility:

Our company qualifies the low-voltage command specification.

(3). Description:

- * Do not rely on leakage protection only for preventing electric shocks. Grounding is required for the protection.
- * Ground each inverter individually (do not connect more than two (including two) ground cables).
- * Please use non-fuse switch and electromagnetic contactor that qualify EN or IEC specifications.
- * Please use the inverter under an environment of over-voltage level-2 condition with contamination level 2 or better.
- * For the style and dimensions of the input- and output-end of the inverter cable, please refer to the specifications listed in the operation manual.

CE Certification Statement

EU-Declaration of Conformity

<i>Herewith we(manufacture):</i>	
<i>Name:</i>	<i>Suzhou Shihlin Electric & Engineering Corporation</i>
<i>Address:</i>	<i>NO.88, Guangdong St., Suzhou New District, Jiangsu, China.</i>

Declare that the following Appliance complies with the appropriate basic safety and health requirements of the EU Directives(see Item 4) and the relevant Union harmonisation legislation based on its design and type, as brought into circulation by us.

The object of the declaration is identification of electrical equipment allowing traceability.

The declaration relates exclusively to Shihlin products in the state in which it was placed on the market, and excludes components which are added and/or operations carried out subsequently by the final user.

This declaration of conformity is issued under the sole responsibility of the manufacture.

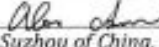
1	<i>Product name:</i>	Inverter
2	<i>Model/Type:</i>	<i>SS2 Series (Reference the attached list of catalogue numbers)</i>
3	<i>Batch or Serial number:</i>	<i>Reference the attached list of catalogue numbers</i>
4	<i>Application EU Directives:</i>	<i>Low voltage Directive 2014/35/EU EMC directive 2014/30/EU</i>
5	<i>Used harmonized Standards:</i>	<i>LVD: EN61800-5-1:2007 EMC: EN61800-3:2004+A1:2012</i>
6	<i>Signed for and on behalf of:</i>	<i>Suzhou Shihlin Electric & Engineering Corporation</i>
7	<i>Print Name, Function(Title of Signature)</i>	<i>Alex Chen, Senior Vice President</i>
8	<i>Signature</i>	
9	<i>Place and date of issue</i>	<i>Suzhou of China, 2017.11.22</i>
<p><i>Manufacturer Statement:</i></p> <p><i>✓ We shall give the manufacturer full name and address, registered trade name or registered trade mark, and true Batch/series no., "xxxx-xxxx" in the EU declaration and on the product(marking plate), or where that is not possible, on its packaging or in a document accompanying the product.</i></p> <p><i>✓ We shall keep the technical documentation referred to in Annex III and the EU declaration of conformity for 10 years after the electrical equipment has been placed on the market.</i></p>		

Catalogue numbers:

<i>Series name of Inverters</i>	<i>Model name</i>	<i>Serial number ¹⁾</i>
<i>SS2-043 Series (3PH 440V)</i>	<i>SS2-043-0.4K, SS2-043-0.75K, SS2-043-1.5K, SS2-043-2.2K, SS2-043-3.7K, SS2-043-5.5K,</i>	<i>N/A</i>
<i>SS2-023 Series (3PH 220V)</i>	<i>SS2-023-0.4K, SS2-023-0.75K, SS2-023-1.5K, SS2-023-2.2K, SS2-023-3.7K,</i>	<i>N/A</i>
<i>SS2-021 Series (1PH 220V)</i>	<i>SS2-021-0.4K, SS2-021-0.75K, SS2-021-1.5K, SS2-021-2.2K,</i>	<i>N/A</i>

1) If no series number is given, then all series are covered

Revision Record

Published Date	Edition of the Manual	Revision Content
December,2011	V1.00	First Edition
October, 2012	V1.01 (Applicable for V0.30 or above firmware)	<ol style="list-style-type: none"> 1. Unifying names of some parameters 2. Amending some mistakes of the instruction manual
February, 2014	V1.02	<p>Addition</p> <ol style="list-style-type: none"> 1. Adding the dimension of H2 in chapter 3.3. 2. Adding the clarification table of parameters. 3. Adding the parameters P.90, P.119, P.255~P.258, P.259, P.260, P.226~P.228 and the related explanations. 4. Adding the DU06 function instructions for P.996~P.999. 5. Adding the explanation about P.998 6. Adding the communication running and speed command selection P.35 7. Adding the multi-function control-terminal input positive/negative logic P.87 8. Adding the multi-function output terminal positive/negative logic P.88 9. Adding the second frequency source P.97 10. Adding the selection of positive and reverse rotation dead time P.119 11. Adding the over torque detection selection P.260 12. Adding the maintenance alarm function P.261 13. Adding the vibration inhibition factor P.286 <p>Modification</p> <ol style="list-style-type: none"> 1. Amending the setting range of P.29, P.40, P.59, P.85, P.290 and adding the related explanations. 2. Amending the explanation about carrier action when P.31=2 3. Amending the explanation of alarm history parameters P.289 and P.291
January, 2015	V1.03	<p>Addition</p> <ol style="list-style-type: none"> 1. Adding the safety instructions. <p>Modification</p> <ol style="list-style-type: none"> 1. Amending the snap-fit installation of DU06.
February, 2016	V1.04	<p>Addition</p> <ol style="list-style-type: none"> 1. Curve equation of output voltage and output frequency <p>Modification</p> <ol style="list-style-type: none"> 1. Modify the part drawing 2. Modify some parameters
November,2017	V1.04+	<p>Modification</p> <ol style="list-style-type: none"> 1. Appendix 6 European Specification Compatibility Description ,CE Certification Statement 2. Nameplate Instruction
January,2018	V1.05	<p>Modification</p> <p>Nameplate Instruction</p>
April,2018	V1.06	<p>Modification</p> <p>3.6.3 Brake resistors</p> <p>Addition</p> <p>Appendix 7 WEEE LOGO</p>

Revision Record

Revision Record

October,2020	V1.07	<u>Modification</u> 1. P.110 “Built-in keypad monitor selection” <u>Addition</u> 1. P.251 “PID pressure range (Bar) setting”
February,2021	V1.08	<u>Modification</u> 1. 5.28 Remote control functionP.61 <u>Addition</u> 1. 5.28 P.219 “Remote function acc/dec time selection” 2. 5.68 P.268 “Voltage stall level “

Version: V1.08

Published Date: February,2021